

WARM TIPS

DUE TO THE PRINTING RELATIONSHIP, THE COLOR OF THE PRODUCT MAY SLIGHTLY DEVIATE FROM THE ACTUAL PRODUCT, PLEASE REFER TO THE ACTUAL PRODUCT, THE PICTURE IS FOR REFERENCE ONLY; SLIGHT COLOR DIFFERENCE BETWEEN THE PRODUCT ALUMINUM PROFILES IT IS NORMAL; THE THICKNESS OF DIFFERENT BATCHES OF ALUMINUM PROFILES HAVE + 0.1MM DEVIATION IS NORMAL. THE COMPANY RESERVES THE RIGHT TO CHANGE THE PRODUCT DESIGN AND SPECIFICATION PARAMETERS, PLEASE REFER TO THE ACTUAL PRODUCT, WITHOUT NOTICE THE COMPANY RESERVES THE RIGHT OF FINAL INTERPRETATION OF THIS BROCHURE.



RUIMEI ALUMINUM HOME

National Franchise Hotline:

400-775-1888



Public account
QR code



WeChat applet
Scan the code to
learn more



Alibaba Customer
Service
Scan to enter the
mobile store

Foshan Ruimei Aluminum Co.

Address: No.10,Guangyun Road,Shishan Town,Nanhai District,Foshan City,Guangdong Province,China.

Call me: 18942402424 Email: 286705065@qq.com

web: www.ruimei-alu.com

ENVIRONMENTAL PROTECTION/LIGHT LUXURY/SIMPLICITY
HIGH END ALL ALUMINUM HOME FURNISHINGS

CCTV
STRATEGIC PARTNERS

COMPANY PROFILE

Foshan Ruimei Aluminum Co., Ltd, founded in 2004 is a focus on extrusion, research and development, raw materials wholesale, processing and customization as one of the all-aluminum furniture profiles ,factory Factory building area are more than 40,000 square meters, with a number of extrusion production lines, woodgrain transfer workshop, honeycomb panel production line, flat sticker production line, welded and

polish production line of the whole plate, finished product production workshop, more than 1,000 square meters of showroom and so on, Achieve independent development of the 10,000 square meters of spot material inventory! Workshop spot supply, customized products, strength and product quality has been recognized by the industry. Main products all-aluminum furniture profiles wholesale, welded panels, all-aluminum honeycomb panels, SPC aluminum honeycomb panels, PETG all-aluminum honeycomb panels, bamboo charcoal panels, PVC aluminum panels, impact panels, ceiling panels, wall decor panel , 20-frame minimalist glass doors, glass cabinets profiles, ancillary processing equipment and other series of furniture decoration and decorative materials, its sales model of wholesale of raw materials, finished products, customized, distribution to join the molding processing and customization in a matter of years! Time, the rise of all-aluminum home so far customers all over the country and Southeast Asia, the company since its inception, adhere to the spirit of craftsmanship, the concept of excellence, became a strategic partner of CCTV, history has witnessed the rapid and stable development of sharp magnesium enterprises.

RuiMei's products, whether it is the selection of materials, technology, quality control or later product inspection standards.Are extremely harsh and rigorous, so that every part of the product color and lustre uniformity, fine texture, to achieve "no defects, zero defects" of the ultimate quality performance.



CORPORATE HONORS



ISO THREE SYSTEM CERTIFICATION



PATENT CERTIFICATE/PRODUCT QUALITY CERTIFICATION



INSPECTION REPORT



6 Champion union endorse
Quality assurance is trustworthy



He Ning

Gymnastics Champion

Guo Dan

Roller Skating Champion

Kong Lingwei

Athletics Champion

Li Shuang

Snowboarding Champion

Sun Yu

Badminton Champion

Liu Tian

diving champion

" RUIMAGNESIUM ALL "
ALUMINUM HEALTHY HOME

TO CROWN ONE'S QUALITY IN THE NAME OF A CHAMPION

TO MAKE ALL ALUMINUM FURNITURE CHOOSE RUIMEI ALUMINUM

ONE-STOP WHOLE-HOUSE CUSTOMIZATION SOLUTION



Extrusion production plant

10,000-square-foot extrusion production plant with multiple extrusion lines.



Surface Color Finish

With wood grain transfer, electrostatic spraying, anodic oxidation, fluorocarbon, outdoor wood grain and other advanced technology



Finished product customization R&D workshop

Professional customized high-end all-aluminum whole set production team
Research and development, innovation as a whole

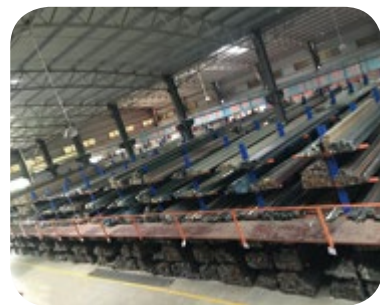

Raw material workshop inventory

10,000-square-foot stockroom, 1,000 tons of inventory, off-the-shelf availability



Welding Plate Shop

Laser welding and 20-head grinding machine, sufficient mass production
No stock out, no shortage of stock. Quality Assurance



Honeycomb panel workshop

Fully automated production line for flat laminating machine and honeycomb panel production line, Trimming machine production line, high production efficiency, high speed

JOIN RUIMEI THE WHOLE SUPPORT

There is no learning, only do not want to learn. Professional technology, professional master, achievement of professional you attentive service to let you open a factory store the whole worry-free

Large integrated advantages to solve the pain points of all-aluminum industry



01

Short Video Shooting Instruction

Short video shooting, easy to get started. Become a professional photographer in seconds



02

Short video editing instruction

Personally instructed by experienced editors, short video Editing instruction to let your creativity fly.



03

Short video operation teaching

We bring you short video operation instruction that Let your creativity and talent bloom on camera!



04

Software teaching

From the material, measurements Installation and production, one-stop service



05

Undercutting instruction

Free technical training by professional masters.Zero-based teaching package



06

The teaching material

Professional masters hand in hand zero basis to start teaching, package teaching, go back to easy to make.



07

Whole house decoration Teaching

No education, no experience, easy to operate, one or two days to learn

**PROFESSIONAL TEAM
FULL SUPPORT THE SECRET TO
CREATING WEALTH TOGETHER**

10 Advantages of RUIMEI

Mature and leading business model for more profits

OPEN A FACTORY AND STORE
THE WHOLE PROCESS IS WORRY-FREE

0 joining fee! 0 agent fee! 0 deposit!

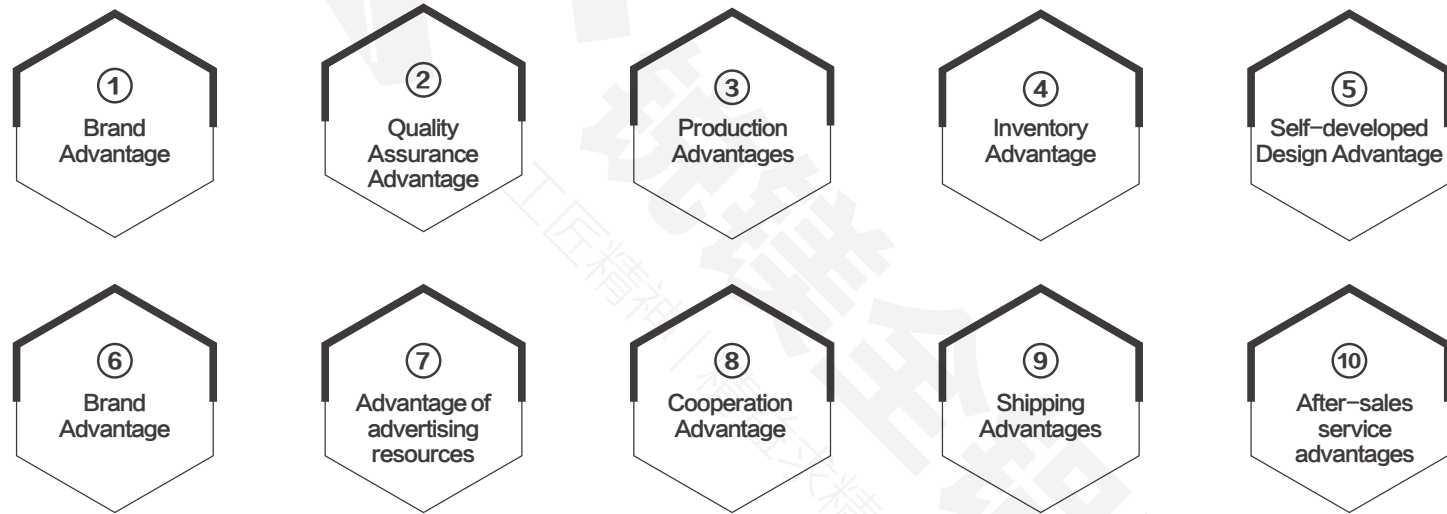

LOW INVESTMENT, HIGH RETURN, EASY TO BE A BOSS

Really open the modern environmental protection furniture era!

All-aluminum alloy cabinet has the absolute advantage that traditional plate cabinet cannot have.

PRODUCTION INVESTMENT PROGRAM

3 Beginner type 30,000 ¥ (Including equipment)

① The project is suitable for people: those who have not done related industries, preliminary understanding of the local market situation. Very optimistic about the product market prospects, want to try to do their own business.

② Investment advice: on a color, make two models to do a variety of samples.

7 Standard type 70,000 ¥ (Including equipment)

① Project suitable for people engaged in the decoration of windows and doors related industry original related customer resources stable, perfect sales network, with the ability to quickly open the market.

② Investment advice on two colors, do more than one product, on all kinds of styles of samples.

5 Entrepreneurial 50,000 ¥ (Including equipment)

① The project is suitable for people: those who have not done related industries, preliminary understanding of the local market situation. Very optimistic about the product market prospects, want to try to do their own business.

② Investment advice on two colors, do more than two products, do a variety of samples.

10 Complete type 100,000 ¥ or more (Including equipment)

① Project suitable for people engaged in cabinet closet finished wholesale more than a year, the existing in doing customer resources stable, perfect sales network, interpersonal relations with the industry in-laws familiar, with a certain influence.

② Invest in more than one kind of color, make more than one kind of products, and get all the samples of various styles.

MODE 1: FRANCHISE STORE MODE



DEALER SUPPORT POLICY

- 01 Complimentary design software
- 02 Product Training
- 03 Free design for front store
- 04 Opening Support
- 05 Design Training
- 06 Customer Push
- 07 Join for free
- 08 Renovation subsidy
- 09 network promotion
- 10 Branding
- 11 sales bonus
- 12 Promotional Materials
- 13 Proactive help support
- 14 Operations Support Training
- 15 Free Sample

**MODE 2: FINISHED
PRODUCT CUSTOMIZATION MODE**

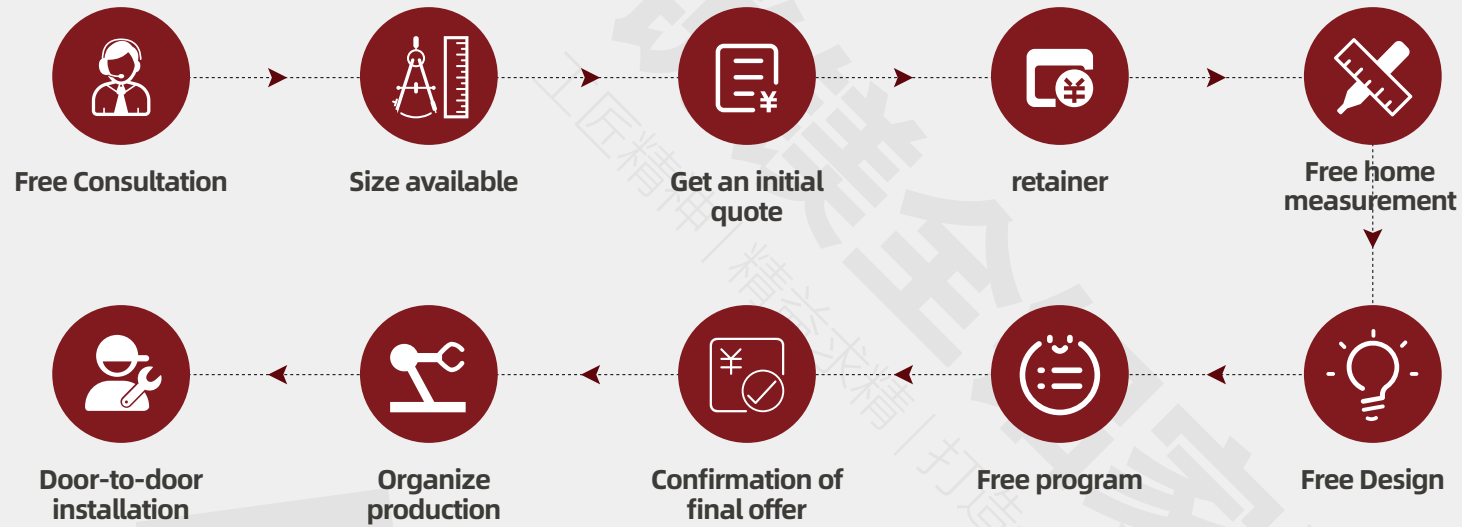

**MODEL III:
PROFILE PROCESSING MODEL**



**RUIMEI ALUMINUM 3D CLOUD DESIGN
SOFTWARE CLOUD RENDERING 720°
PANORAMIC EXPERIENCE**

A L U M I N I U M A D V A N T A G E S

BUY ALUMINUM, SOFTWARE FREE FOR YOU
10 ADVANTAGES, LET YOU EASILY ORDER.



| | | | |
|--|---|---|---|
| <p>1 Simple operation. Zero learning cost</p> | | <p>2 1 minute house type.3-minute rendering</p> | <p>3 Fully realistic 3D models. VR panoramic experience</p> |
| <p>4 Massive gallery of Massive 3D model material library</p> | <p>5 Comes with a free instructional course, it's easy to get started and worry-free operation</p> | <p>7 Intelligent sample room free replacement. Free filtering, replacement, modification</p> | <p>9 Sales gods, cell phone one- click marketing, improve customer source, easy to take orders</p> |
| | <p>6 Design case WeChat, microblogging, website and other easy to get started online sharing</p> | <p>8 Cloud-rendered 720° panoramic roaming with automatic mobile/PC browsing</p> | <p>10 Saving labor, avoiding calculation errors, self-pick up the amount of work, one-click budget quote</p> |



10 ADVANTAGES OF ALL ALUMINUM FURNITURE GIVE YOU A REASSURING REASON TO CHOOSE RUIMA



DAMP PROOF AND WATERPROOF

Good moisture-proof performance, more suitable for humid areas



FIRE PROTECTION

Aluminum alloy has strong heat-resistant properties, overcoming the shortcomings of the general general sheet can not withstand burning.



GREEN FORMALDEHYDE FREE

All-aluminum furniture does not require any formaldehyde-containing materials in the production process, truly realizing zero formaldehyde.



BEAUTIFUL AND GENEROUS

Imitation of real wood texture and color, visual noble and elegant, fine and realistic lines. Stable than real wood, no dulling, no fading.



IMPACT RESISTANCE

Aluminum cabinets have strong impact resistance, stable structure, and bending strength up to 150Mpa.



EXCELLENT DURABILITY

Precision aluminum molding cabinet, to meet the quality requirements of the outdoor curtain wall, to ensure that the product is durable for decades.

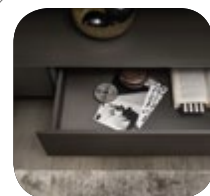

NO ODOR

The cabinet is made of aluminum alloy frame splicing, alloy fittings processed in a clean environment, the product has no odor.



RECYCLE AND PRESERVE VALUE

The cabinet is made of refined aluminum alloy, and if you replace the furniture, you can recycle it at any recycling point around the area.



IMMUNE TO MOTHS

All-aluminum homes are tough and never rot. Resistant to termites, insects and other infestations



CONVENIENT INSTALLATION

Streamlined process Quick to install, dismantle and move at will, Recyclable and retrofittable

ALL-ALUMINUM HONEYCOMB PANEL

All-aluminum honeycomb panel stock thickness: 18mm, 16mm, 10mm, 7mm, 5mm (support custom size thickness color)

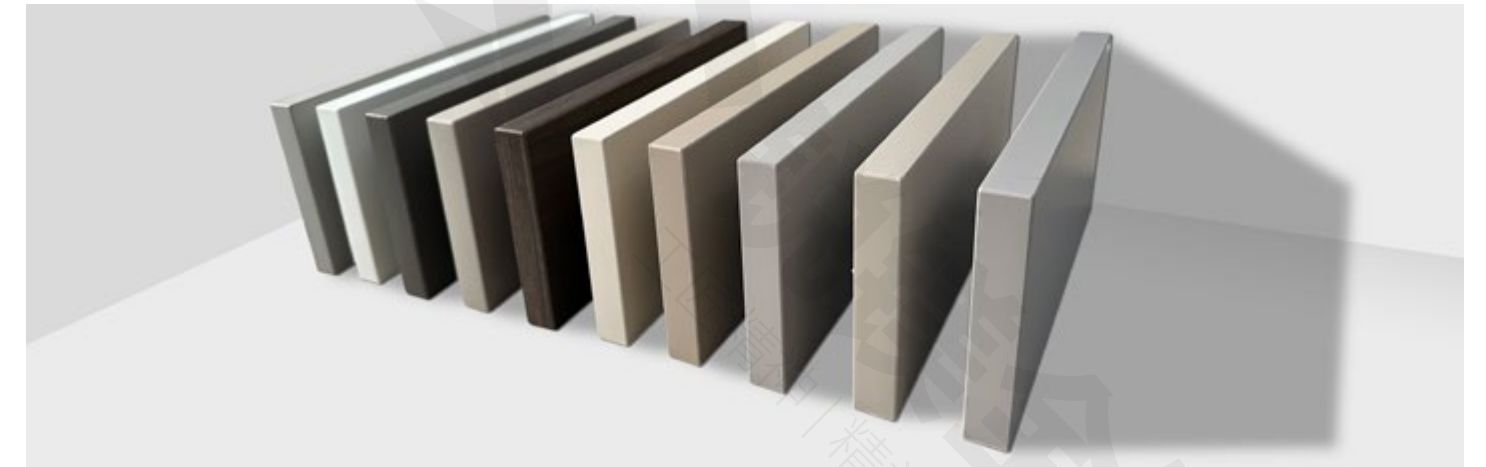

PETG honeycomb board series

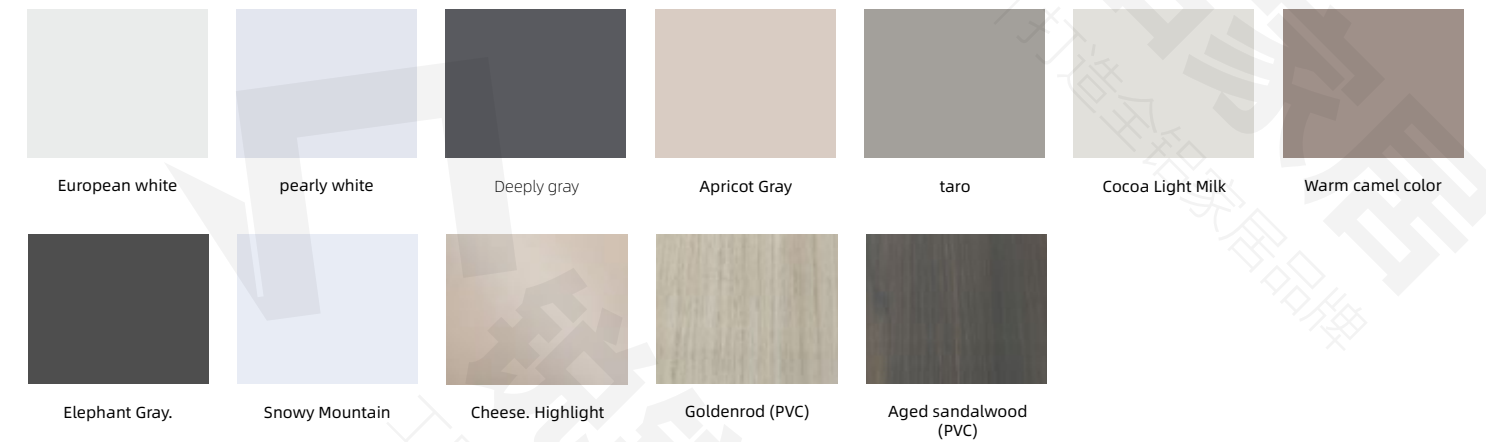

SPC/PVC Aluminum Honeycomb Panel Series



18mm honeycomb panel color card

Solid Color – Electrostatic Coating



Wood Grain–Wood Grain Heat Transfer



SN anti-scratch 3D wood grain hand grain series

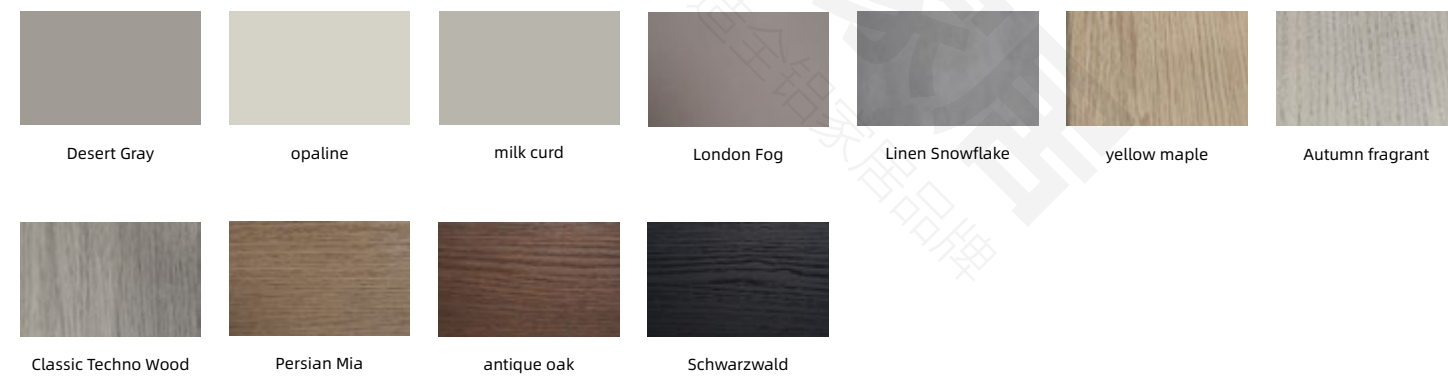

GAUDIN ALL-ALUMINUM HOME PANELS

NEW ENVIRONMENTALLY FRIENDLY SUBSTRATE FOR ALL ALUMINUM HONEYCOMB PANELS NEW MATERIAL SELECTION FOR ALL ALUMINUM FURNITURE

High quality materials+high-strength craftsmanship+precision machining=wear-resistant, scratch resistant, and dust-free

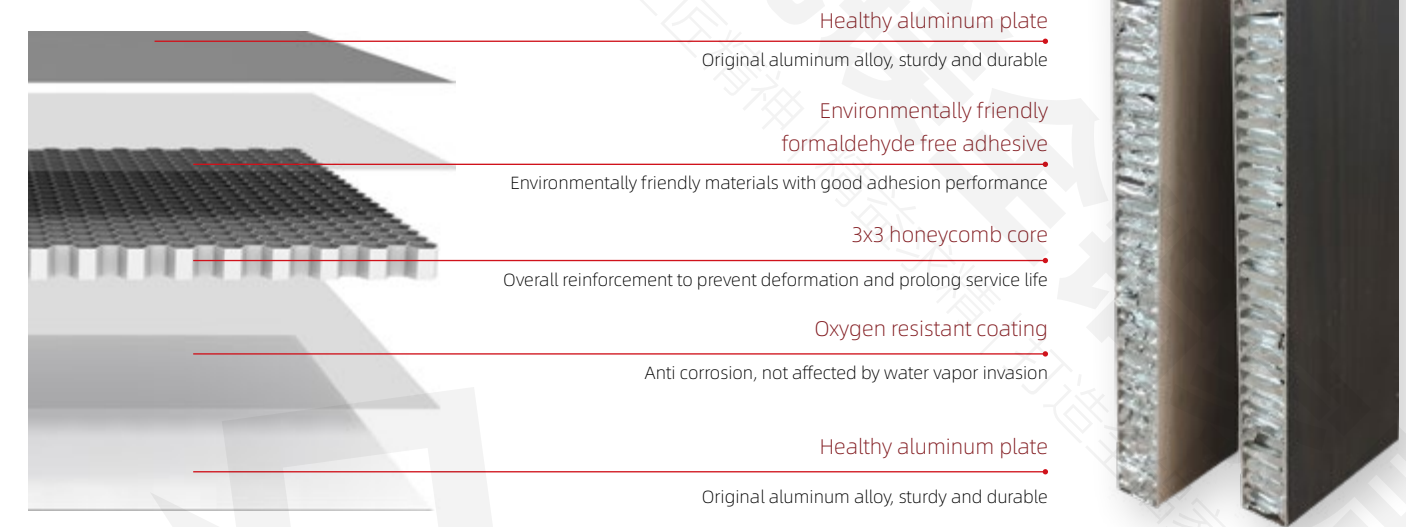

NEW PRODUCT RECOMMENDATION: MULTI-LAYER ALL ALUMINUM HONEYCOMB PANEL HIGH END ALL ALUMINUM PREFERRED, WITH ONE DOOR TO THE TOP THAT NEVER DEFORMS AND TOP REINFORCEMENT DESIGN

Multi-layer honeycomb panels also have excellent corrosion resistance and durability, and can be used to manufacture corrosion-resistant materials and durable structures and products. At the same time, multilayer honeycomb panels can be customized to meet different needs and requirements, allowing structures and products to be manufactured in a variety of shapes and sizes.

Wood grain/spray painting/film application process

Rich in colors, wear-resistant and scratch resistant, comfortable to the touch

Four layer aluminum plate

Original aluminum alloy, sturdy and durable

Three layer honeycomb core

Has high bending stiffness for layered structures

Environmentally friendly formaldehyde free adhesive

Increase overall strength and stronger load-bearing capacity

Oxygen resistant coating

Effectively suppress the reaction between metal surface and oxygen

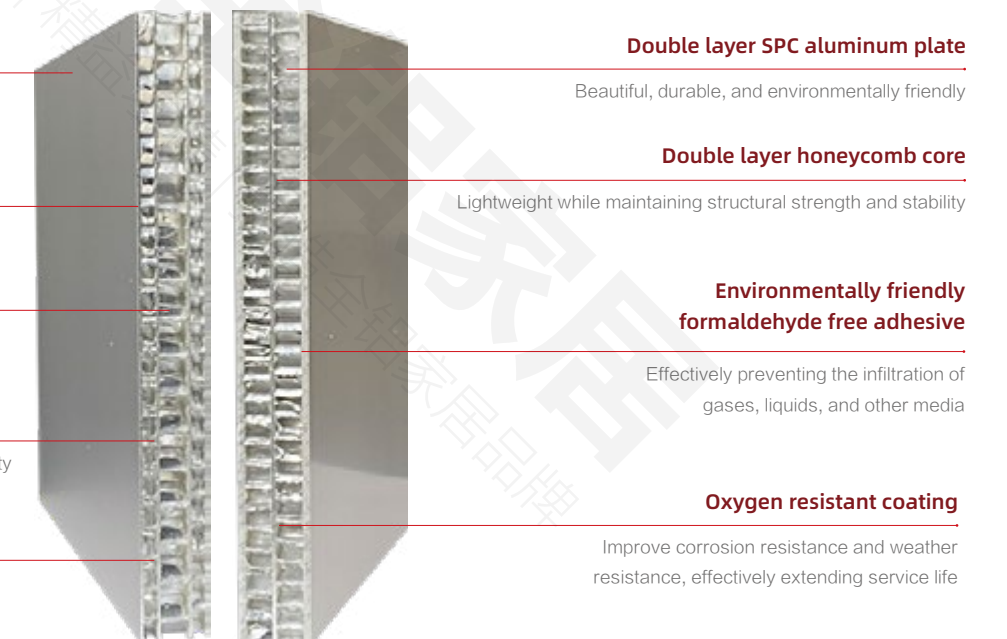

**PETG EXCIMER FILM ALL-ALUMINUM HONEYCOMB PANEL
HIGH PRESSURE RESISTANCE WITHOUT DEFORMATION**

1. Made of metal, so easy to recycle, is a green product, light weight, high strength, rigidity and good tear resistance.
2. Excellent weathering performance: High temperature resistance, corrosion resistance, aging resistance, and flatness is also very high.
3. The boards are large, with variable modulus and high flatness. Customization is possible and can meet the needs of different customers.
4. Flame retardant, sound insulation, heat insulation effect is good. It is also characterized by strong decorative properties, easy processing and stable performance.

PRODUCT FEATURES

18mm honeycomb aluminum core

Bionic honeycomb structure, dispersed force, structural stability, not easy to deform, more durable, upgrading the overall stability, long time no cabinet deformation worry.

PETG Excimer Film Panel Flat Lamination

Smooth feel, not easy to change color, easy to clean, bright color, not yellowing, with a strong visual effect, and has a high hardness, scratch resistance



**STONE STEEL SPC ALUMINUM HONEYCOMB PANEL
BATHROOM CABINET PREFERRED PANEL, LOW COST**

SPC Aluminum Honeycomb Aluminum Panel is a kind of raw material for all-aluminum furniture customization, which has the advantages of light weight, high strength, corrosion resistance, environmental protection and so on. It is made of aluminum alloy panel and the middle honeycomb aluminum alloy core plate through hot press forming technology, which has good heat insulation, sound insulation, moisture resistance and other properties. The cabinets made by directly sealing the edges are fully automated and highly efficient.

PRODUCT FEATURES

1. **Rugged and strong:**
Hexagonal aluminum honeycomb core design can greatly attenuate the thermal expansion problem of the panel
2. **Waterproof and fireproof is safer:**
Waterproof, moisture-proof, dirt-proof, near-zero thermal expansion and contraction, aluminum alloy surface effectively flame retardant
3. **Soundproofing and insulation for greater comfort:**
Honeycomb core structure, effectively blocking sound penetration, sound and heat insulation effect is better
4. **Mildew and stain resistant and easy to clean:**
The PETG layer on the surface of the sheet is resistant to oxidation, oil and dirt. Easy to clean and protected from water vapor

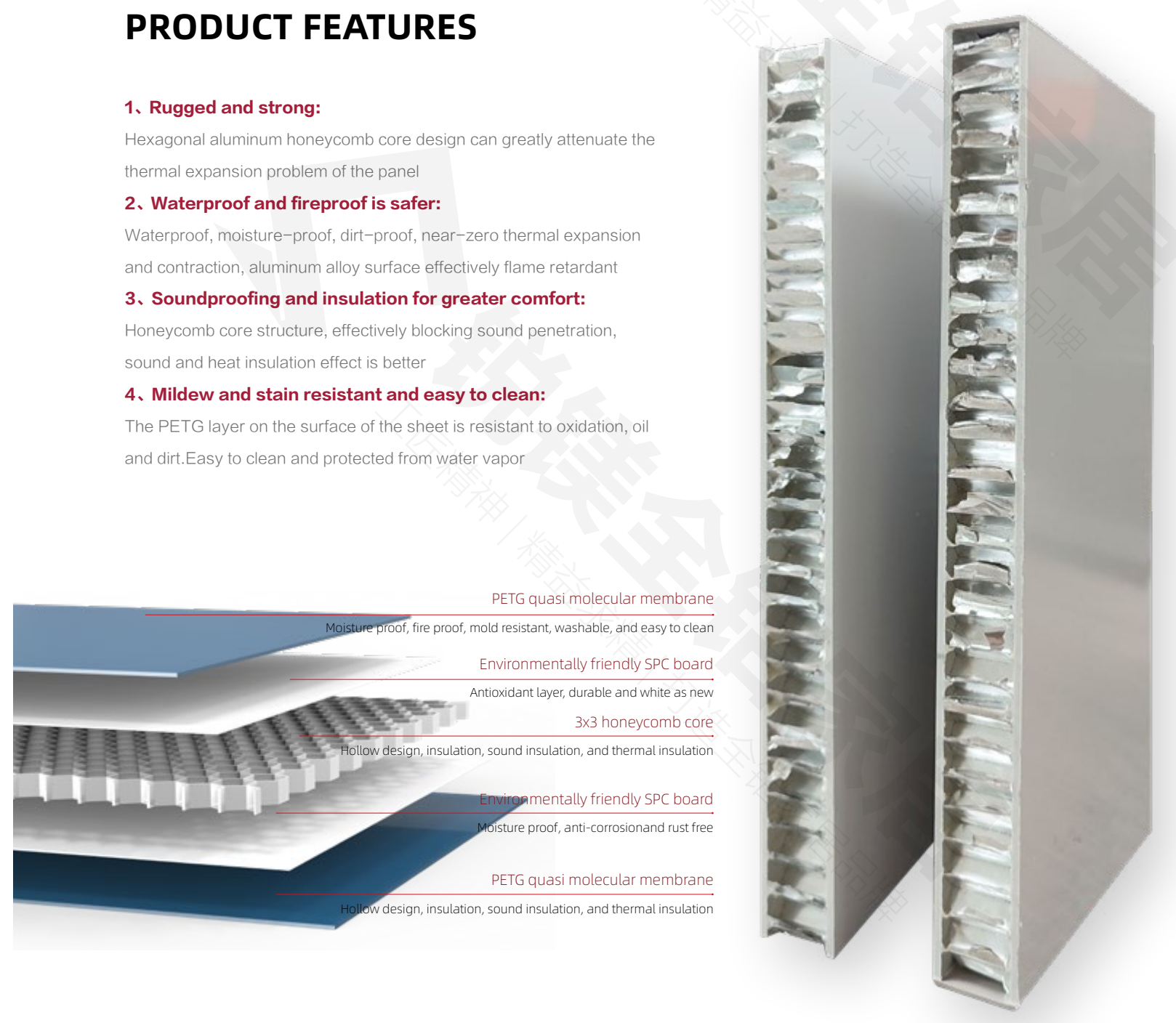

AVIATION-GRADE ALUMINUM KUN PLATE

FIRE-RETARDANT AND FIRE-RETARDANT STRONG AND DURABLE

Aluminum Kun board to bamboo charcoal as the main raw material, selected more than 4 years of high-quality moso bamboo, in high-temperature conditions moso bamboo fully pyrolysis carbonization, carbonization, crushing and grinding, to 350 mesh ultra-fine precision pelleting, and then add self-developed environmentally friendly ingredients, by the high-tight equipment high-temperature extrusion of one-time molding.

PRODUCT FEATURES

Activated Bamboo Charcoal Fiber

With bamboo charcoal as the main raw material, bamboo charcoal is a natural green material with non-toxic, harmless and non-polluting characteristics. At the same time, bamboo charcoal fiber board has good heat preservation and insulation properties, which can effectively lower the indoor temperature and reduce energy consumption.

THE BONDING QUALITY BETWEEN 6063 PRIMARY ALUMINUM SHEET AND HIGH-DENSITY CARBON FIBER IS EXCELLENT

- 01 Healthy Aluminum
- 02 Healthy Aluminum
- 03 Activated Carbon Bamboo Charcoal Substrate
- 04 Frosted textured layer
- 05 Frosted textured layer

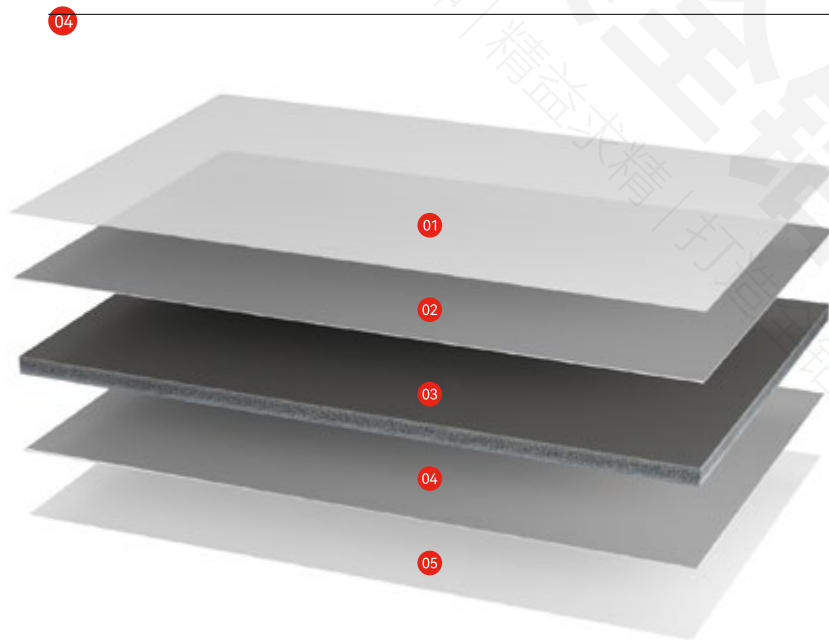

ALL-ALUMINUM BUMPER DECORATIVE PANELS FOR WALL PANELS

BACKGROUND WALL, DECORATIVE PANELS, DOOR PANELS, CABINET BACK PANELS, ETC.

With the advantages of green environmental protection, high strength, fireproof and waterproof, easy installation, good corrosion resistance, beautiful appearance, waterproof and moisture-proof and economical, the all-aluminum bumper panel is an excellent interior decoration material. Aluminum siding is very strong and has excellent performance in withstanding wind pressure, wind load, air pressure and other forces.

PRODUCT FEATURES

- 一、 **light weight:**The density of aluminum alloy is lower than that of steel, iron and other materials, so the quality of aluminum alloy bumper plate is relatively light.
- 二、 **Corrosion resistant:**Aluminum alloy is easy to form a dense oxide film in the air, which has good corrosion resistance. Therefore, the aluminum alloy anti-collision plate has a long service life and low maintenance cost.
- 三、 **impact resistance:**Aluminum alloy has a certain degree of strength and stiffness, and can withstand a certain degree of impact. At the same time, aluminum alloy bumper plate has better elasticity
- 四、 **easy processing:**Aluminum alloy has good machinability and can be cut, drilled, bent, and other machining operations for ease of fabrication and installation.

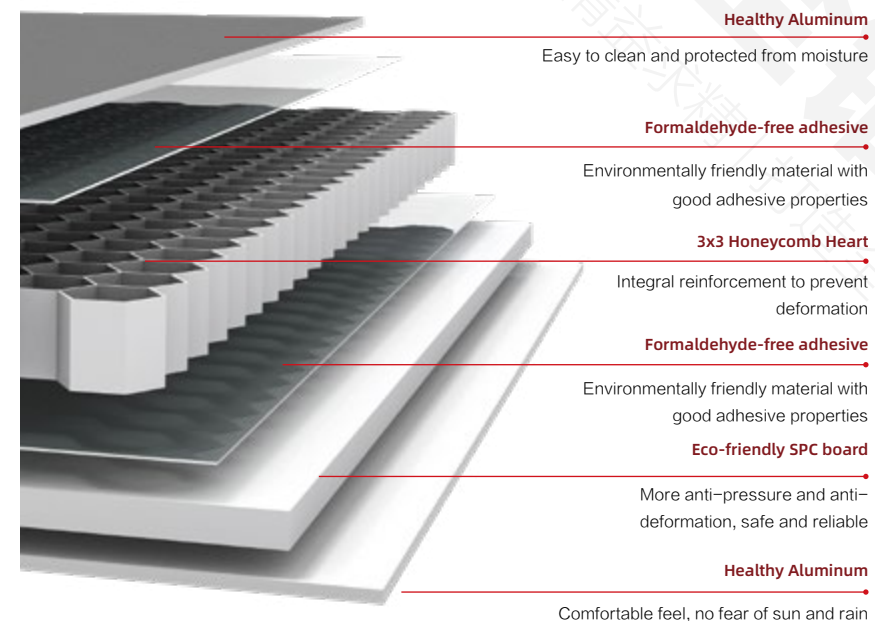

QUICK INSTALL ALL ALUMINUM WHOLE PLATE

MATERIAL THICKNESS 0.7, 0.8, 1.0, LENGTHS 4.9 AND 6 METERS
WIDTHS 50-1000, 18 SIZES IN TOTAL

SUPPORT CUSTOMIZED
COLORS AND SIZES



Welded full panel cabinet color

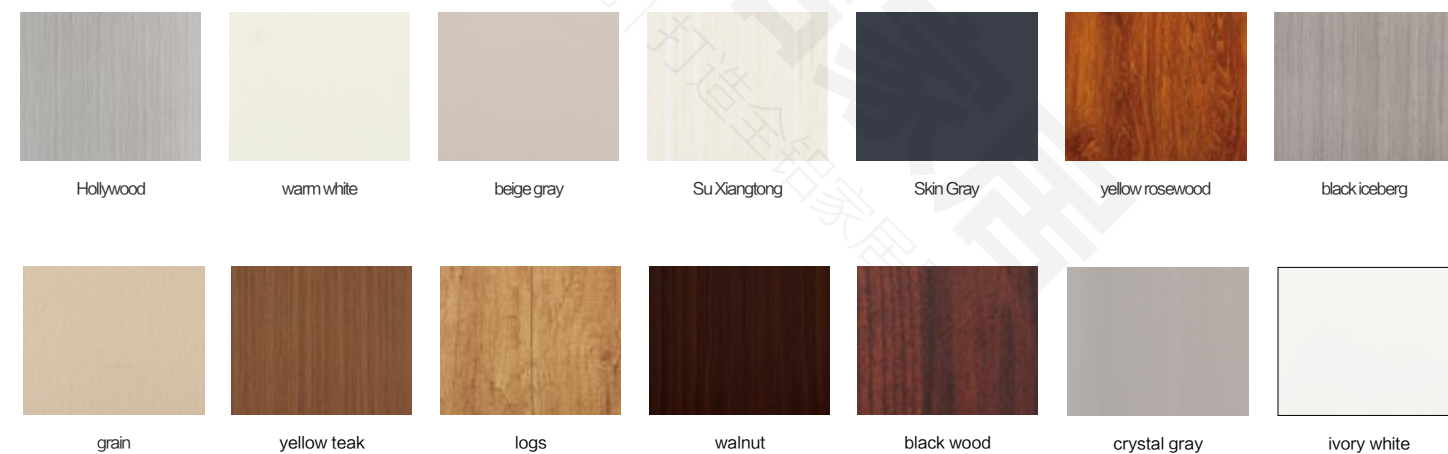

Welded Whole panel cabinet color



Spot Series(Ceiling)-Honeycomb Panel

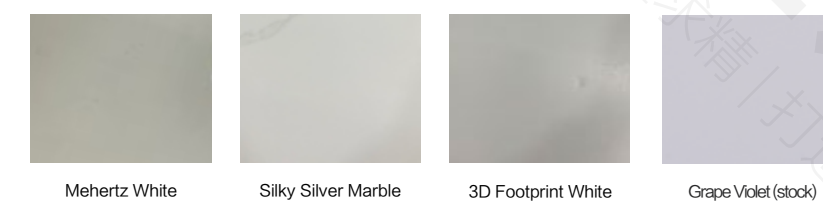

Customized Series (Ceiling) - Honeycomb Panel



ONE-PIECE MOLDED DOOR JAMB PROFILE DRAWING



Dumbwaiter

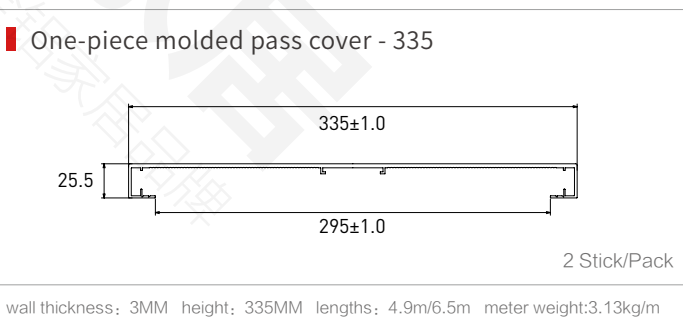
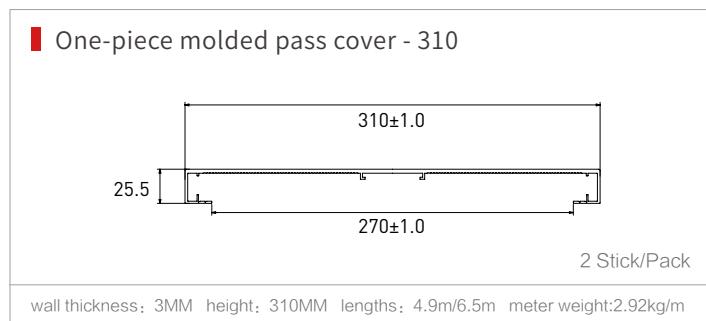
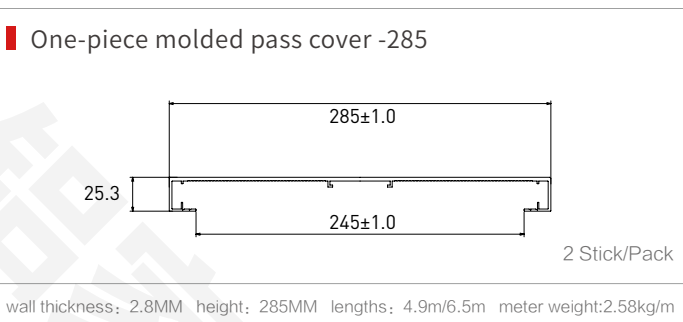
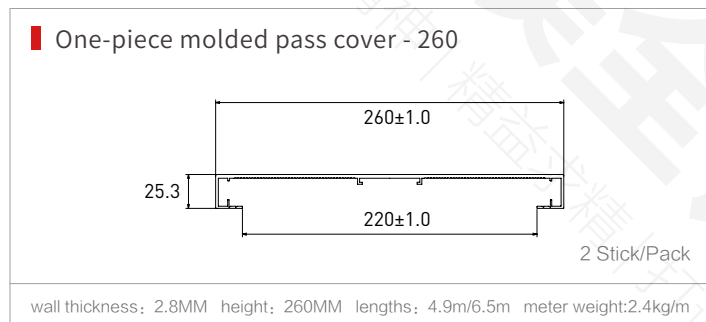
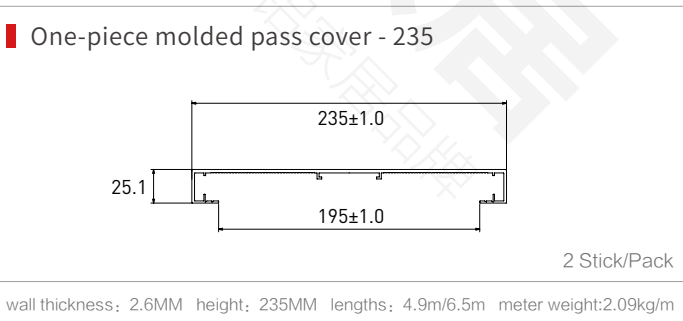
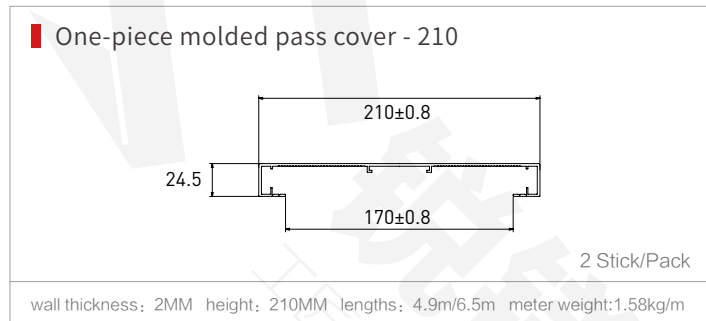
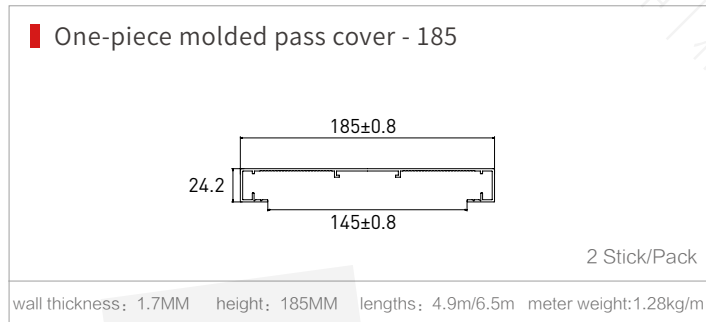

10mm welded plate series profile drawing (wall thickness 0.8mm)

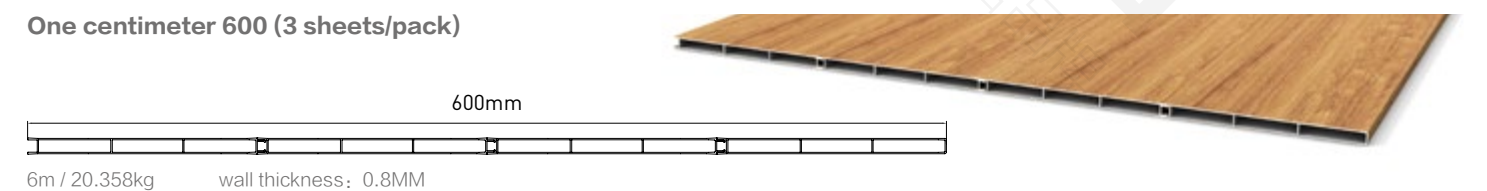
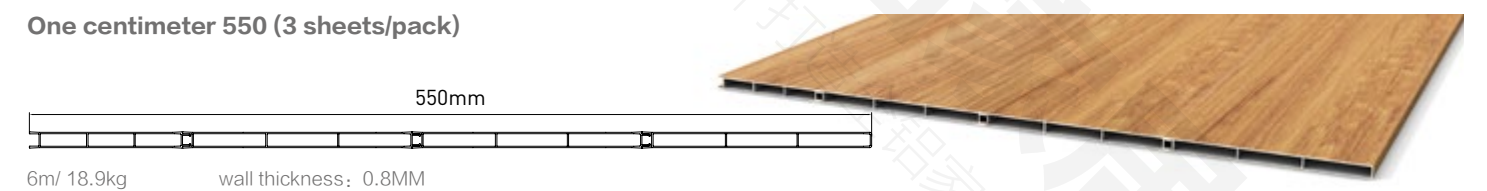
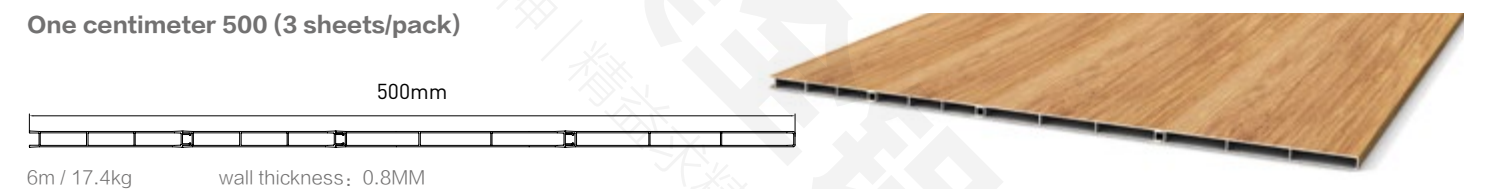
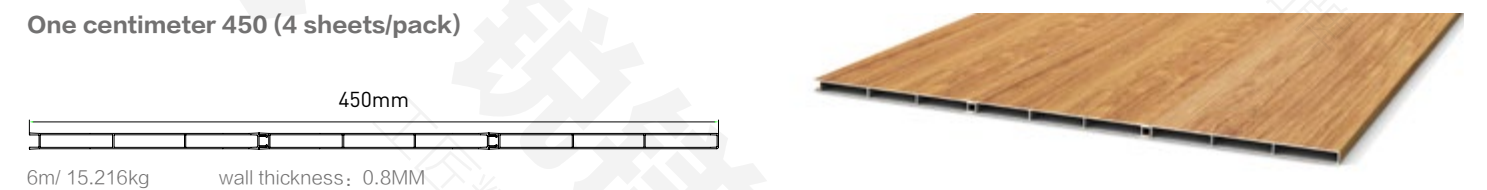

10mm welded plate series profile drawing(wall thickness 0.8mm)

One centimeter 650 (2 sheets/pack)

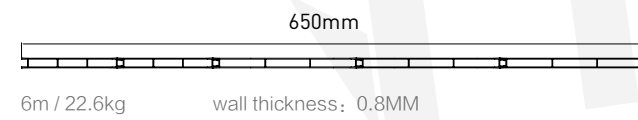

One centimeter 700 (2 sheets/pack)



One centimeter 750 (2 sheets/pack)



One centimeter 800 (2 sheets/pack)

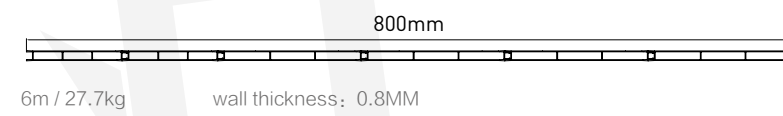

One centimeter 850 (2 sheets/pack)

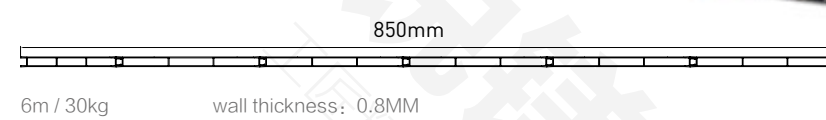

One centimeter 900 (2 sheets/pack)

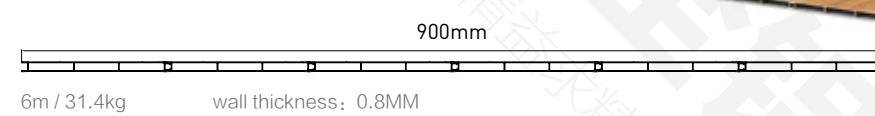

One centimeter 950 (2 sheets/pack)

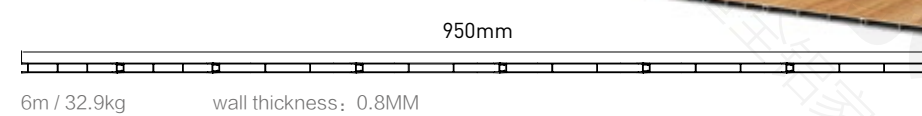

One centimeter 1000 (2 sheets/pack)

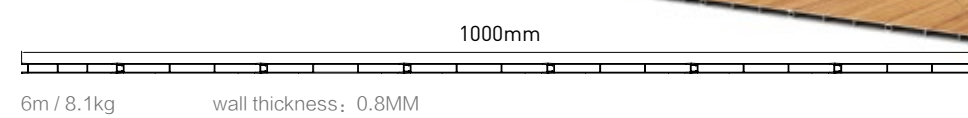

18mm welded plate series profile drawing (wall thickness 0.8mm)

18mm welding plate 200 (5/pack)

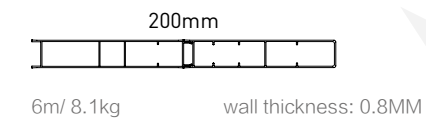

18mm welding plate 250 (5/pack)

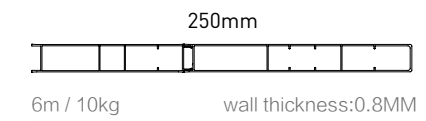

18mm welding plate 300 (5/pack)

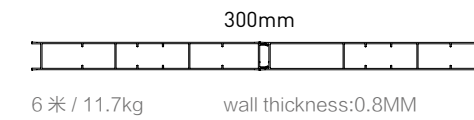

18mm welding plate 350 (5/pack)

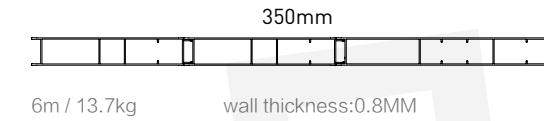

18mm welding plate 400 (4/pack)



18mm welding plate 450 (4/pack)

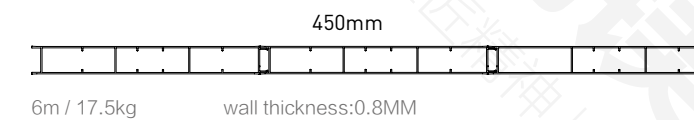

18mm welding plate 500 (3/pack)

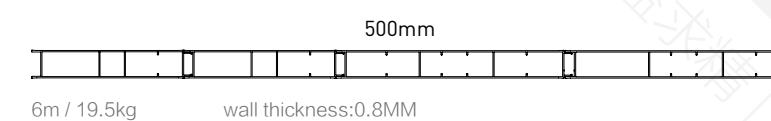

18mm welding plate 550 (3/pack)

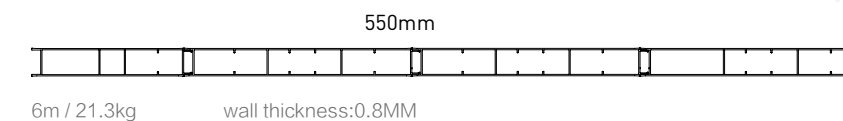

18mm welding plate 600 (3/pack)

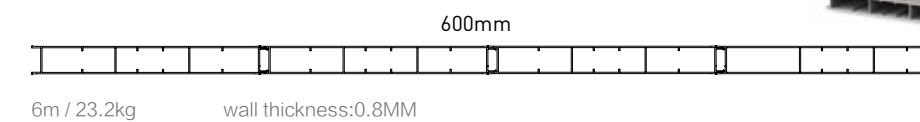

18mm welded plate series profile drawing (wall thickness 0.8mm)

18mm welding plate 650 (2/pack)

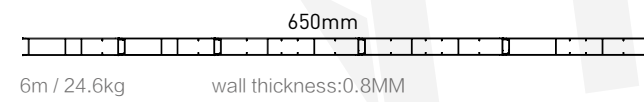

18mm welding plate 700 (2/pack)

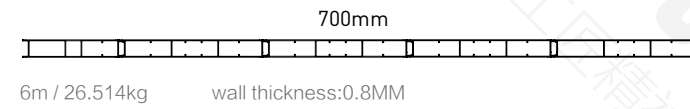

18mm welding plate 750 (2/pack)

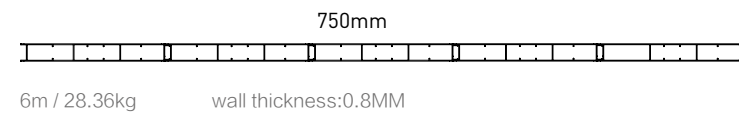

18mm welding plate 800 (2/pack)

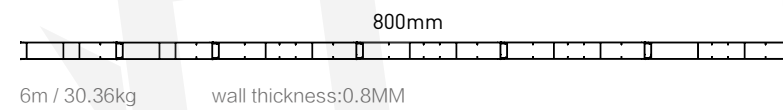

18mm welding plate 850 (2/pack)

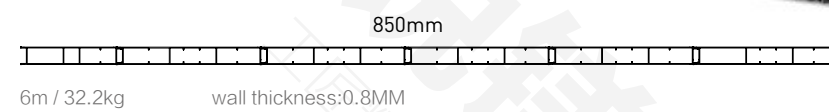

18 厘焊接板 900 (2 张 / 包) 18mm welding plate 600 (3/pack)

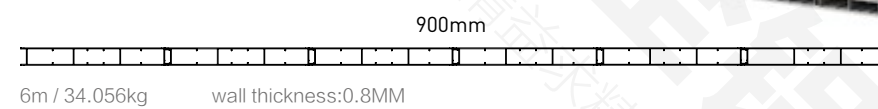

18mm welding plate 950 (2/pack)

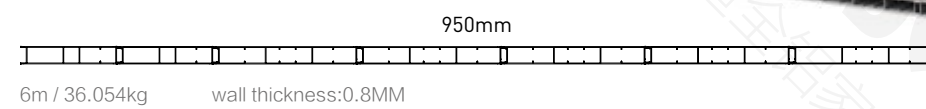

18mm welding plate 1000 (2/pack)

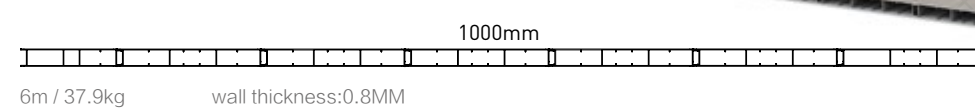

18mm welded plate series profile drawing (wall thickness 0.8mm)

18mm welding plate 250 (5/pack)

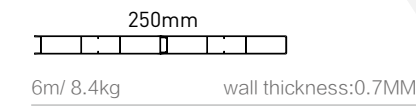

18mm welding plate 300 (5/pack)

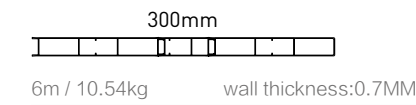

18mm welding plate 350 (5/pack)

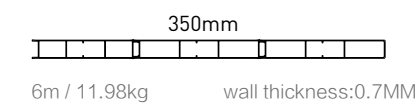

18mm welding plate 400 (4/pack)

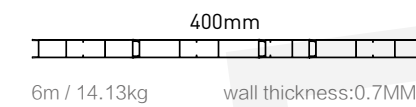

18mm welding plate 450 (4/pack)

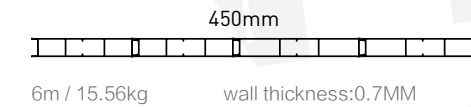

18mm welding plate 500 (3/pack)

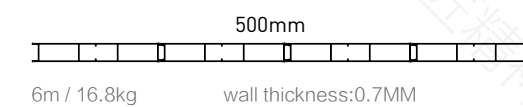

18mm welding plate 550 (3/pack)

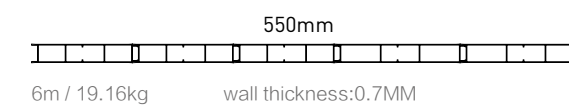

18mm welding plate 600 (3/pack)

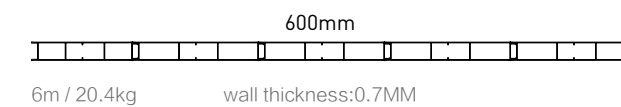

18mm welding plate 650 (2/pack)

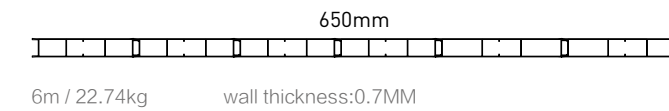

18mm welded plate series profile drawing (wall thickness 0.8mm)

18mm welding plate 700 (2/pack)

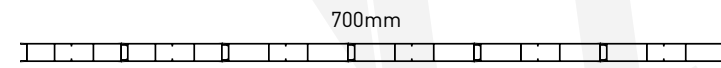

6m / 23.99kg wall thickness:0.7MM



18mm welding plate 750 (2/pack)

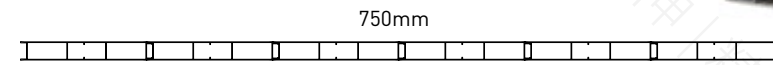

6m / 25.23kg wall thickness:0.7MM



18mm welding plate 800 (2/pack)

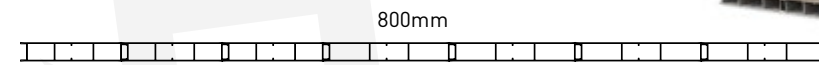

6m / 27.58kg wall thickness:0.7MM



18mm welding plate 850 (2/pack)

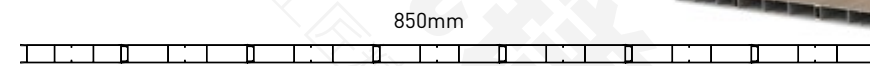

6m / 28.82kg wall thickness:0.7MM



18mm welding plate 900 (2/pack)

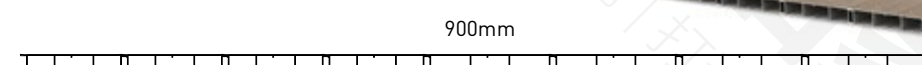

6m / 31.17kg wall thickness:0.7MM



18mm welding plate 950 (2/pack)

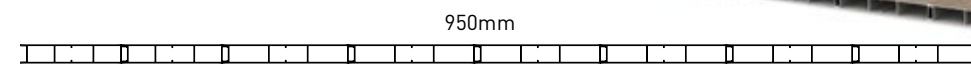

6m / 32.41kg wall thickness:0.7MM

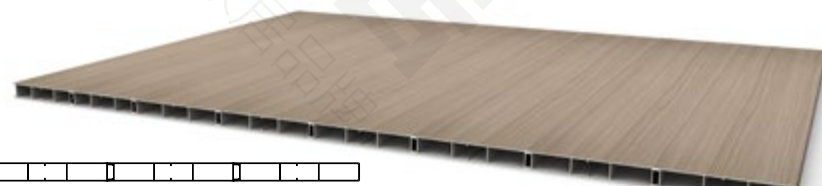

25mm welded plate series profile drawing (wall thickness 0.8mm)

25mm welding plate 700 (2/pack)

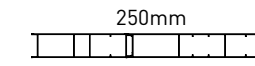

6m / 11.2kg wall thickness:0.8MM

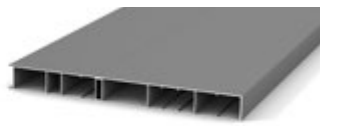

25mm welding plate 300 (3/pack)

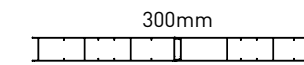

6m / 13.2kg wall thickness:0.8MM



25mm welding plate 350 (3/pack)

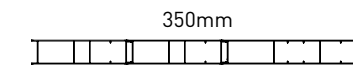

6m / 15.7kg wall thickness:0.8MM



25mm welding plate 400 (3/pack)

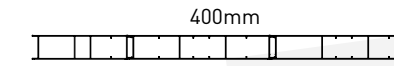

6m / 17.8kg wall thickness:0.8MM



25mm welding plate 450 (2/pack)

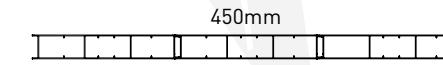

6m / 19.8kg wall thickness:0.8MM



25mm welding plate 500 (2/pack)

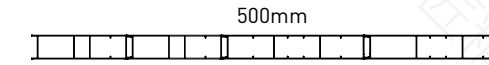

6m / 22.3kg wall thickness:0.8MM



25mm welding plate 550 (2/pack)

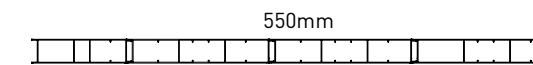

6m / 24.4kg wall thickness:0.8MM



25mm welding plate 600 (2/pack)

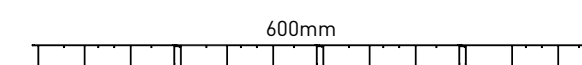

6m / 26.4kg wall thickness:0.8MM



25mm welding plate 650 (2/pack)

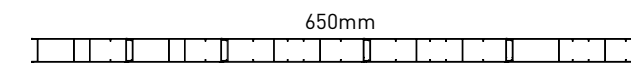

6m / 28.9kg wall thickness:0.8MM



25mm welded plate series profile drawing (wall thickness 0.8mm)

25mm welding plate 700 (2/pack)

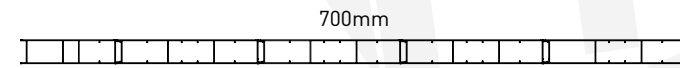

6m / 31kg wall thickness:0.8MM



25mm welding plate 750 (2/pack)

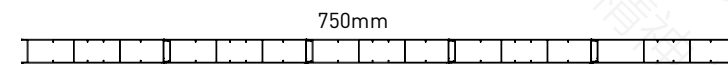

6m / 33kg wall thickness:0.8MM



25mm welding plate 800 (2/pack)

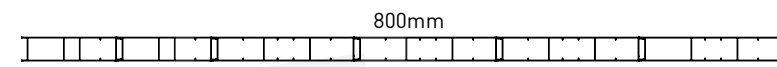

6m / 35.6kg wall thickness:0.8MM



25mm welding plate 850 (2/pack)

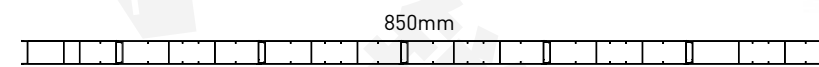

6m / 37.6kg wall thickness:0.8MM



25mm welding plate 900 (2/pack)

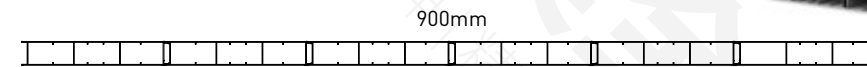

6m / 39.6kg wall thickness:0.8MM



25mm welding plate 950 (2/pack)

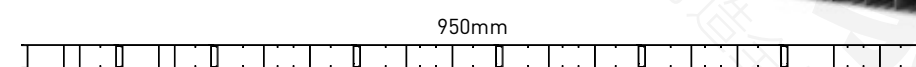

6m / 42.1kg wall thickness:0.8MM



25mm welding plate 1000 (2/pack)

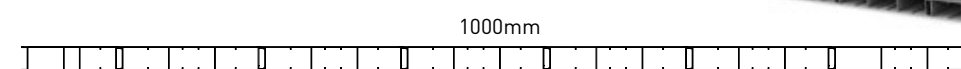

6m / 44.1kg wall thickness:0.8MM



CONTENTS

| | |
|---|----|
| HONEYCOMB BOARD MATCHING HANDLE SERIES | 30 |
| BATHROOM CABINET SERIES | 31 |
| HONEYCOMB PANEL OUTER FRAME DOOR SERIES | 31 |
| MINIMALIST GLASS DOOR SERIES | 32 |
| MINIMALIST GLASS DOOR SERIES | 31 |
| LUMINOUS ALUMINUM PANEL CABINET | 37 |
| WALL/CEILING SERIES | 38 |
| ALL ALUMINUM GRILLE / WALL PANEL | 39 |
| CABINET LIFT | 40 |
| WARDROBE SERIES | 46 |
| WINE CABINET SERIES | 52 |
| TATAMI SERIES | 54 |
| BOOKCASE SERIES | 58 |
| TV CABINET SERIES | 62 |
| SHOE CABINET SERIES | 68 |
| BALCONY CABINET SERIES | 71 |
| BATHROOM CABINET SERIES | 74 |
| ALUMINUM DOOR SERIES | 76 |
| DOOR PANEL SERIES | 78 |
| CERAMIC ALUMINUM CABINET SERIES | 80 |
| MINIMALIST DOOR ACCESSORIES SERIES | 81 |
| PROFILE SERIES | 82 |
| ACCESSORIES SERIES | 90 |
| MECHANICAL EQUIPMENT SERIES | 95 |

18mm honeycomb panel matching handle series

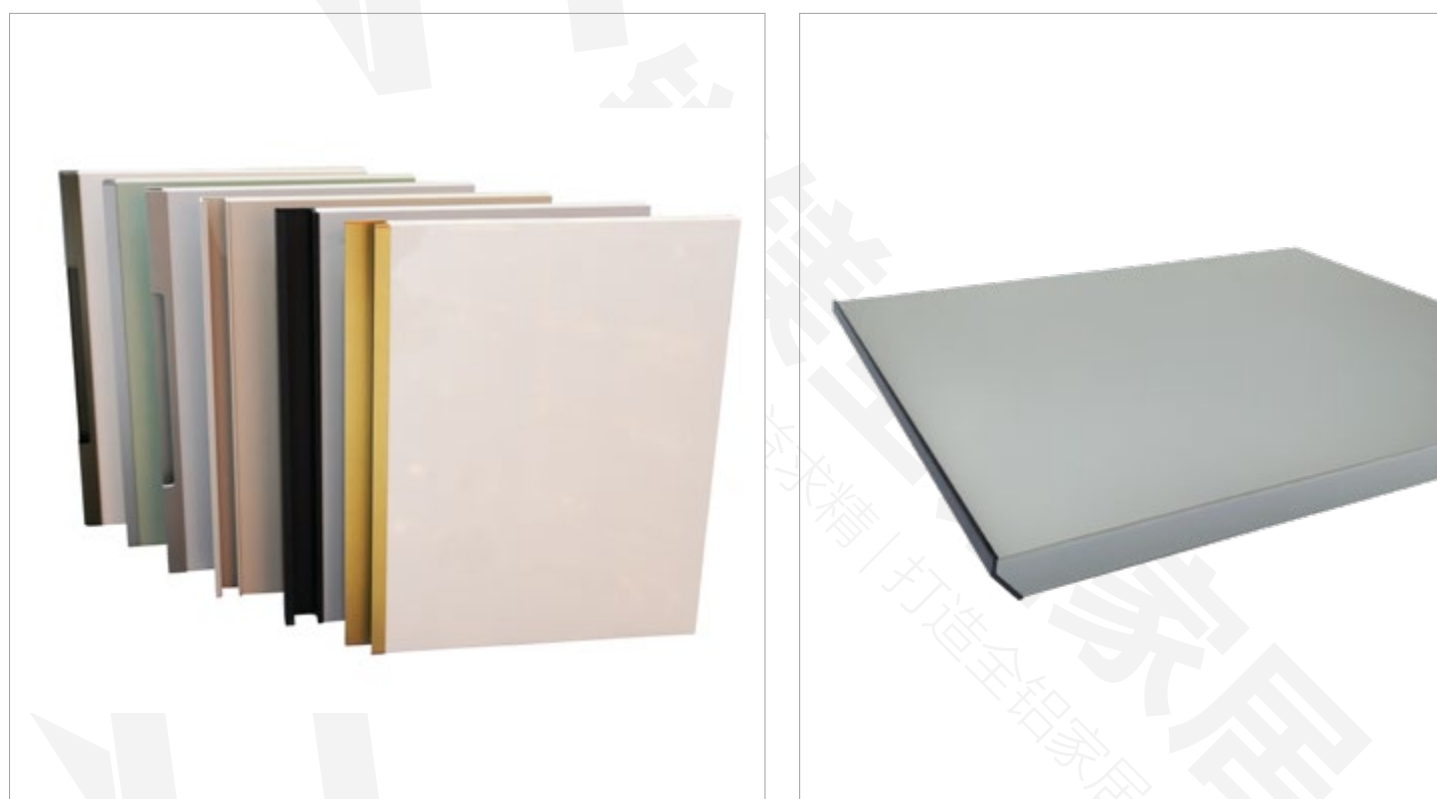

18mm honeycomb panel matching handle series

PROFILE DIAGRAM

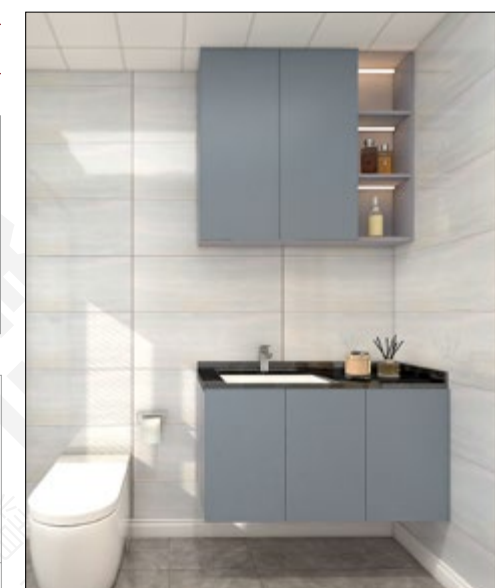

PROFILE DIAGRAM

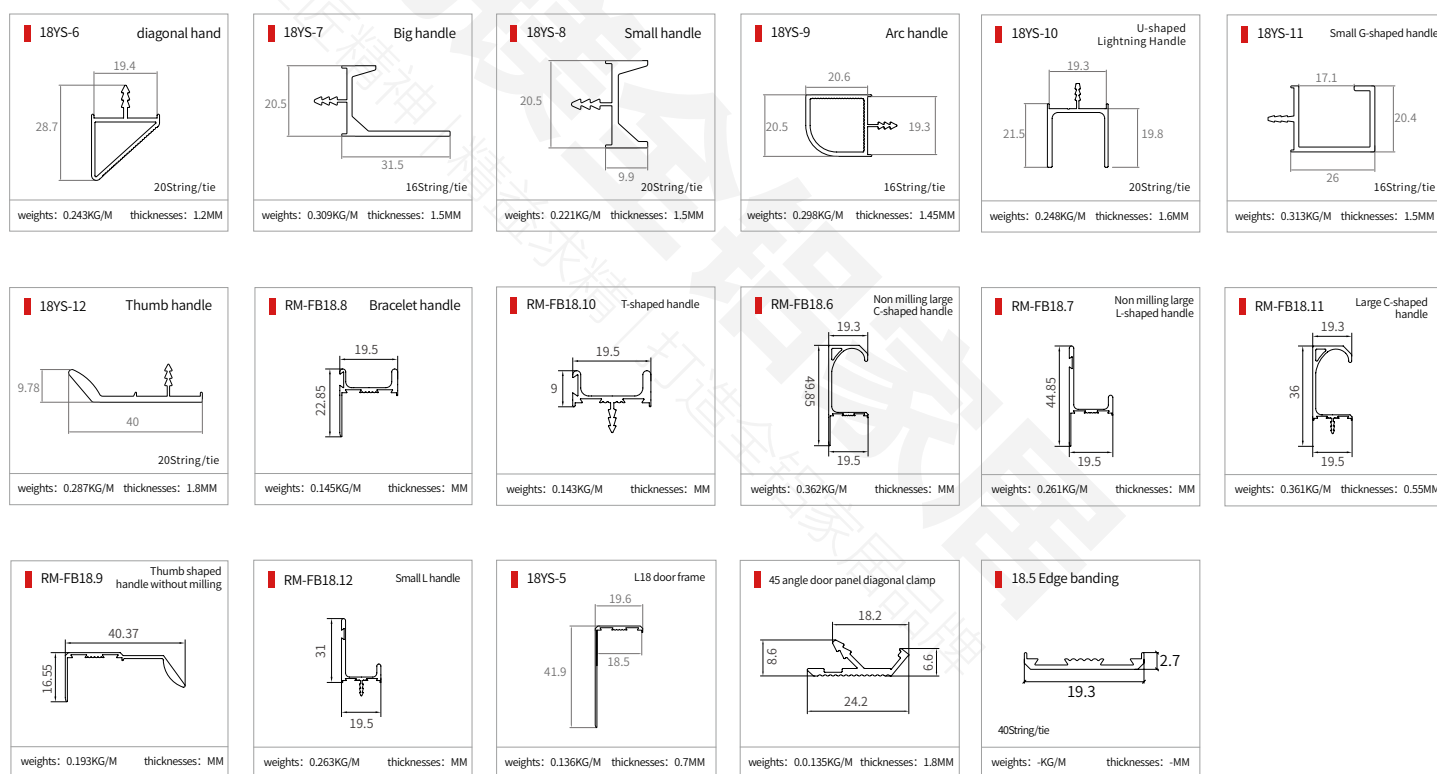

18 honeycomb panel outer frame door series



PROFILE DIAGRAM

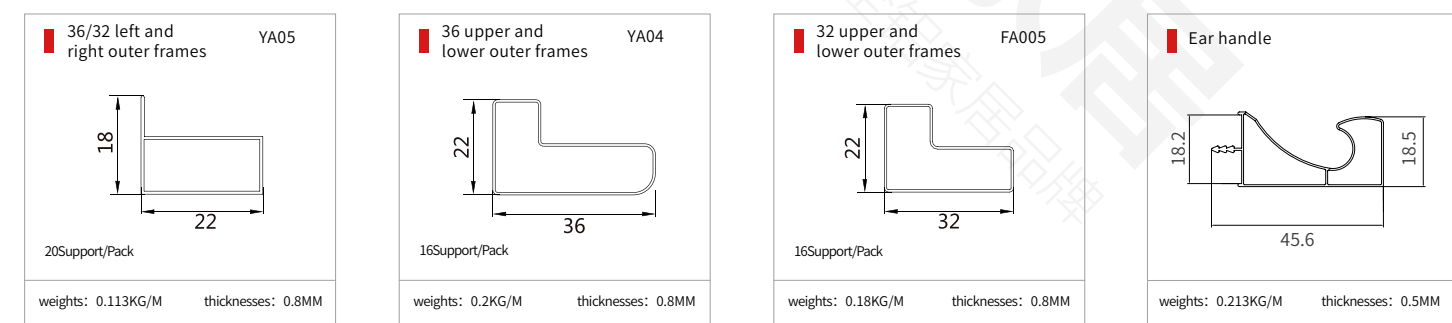

60 right angled diagonal door

Product configuration

Board core matching: glass, boards with a thickness of less than 5mm

Specifications: 2.6 meters, 2.7 meters, 3 meters

Color: Matte black, gray coffee

Efficient CNC aluminum milling integrated machine



PROFILE

60 right angled diagonal border



10Stick/Pack

weights: 0.496KG/M thicknesses: 1.0MM

60 boxes on top and bottom

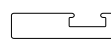

20Stick/Pack

weights: 0.268KG/M thicknesses: 6.0MM

Hardware Functional Parts

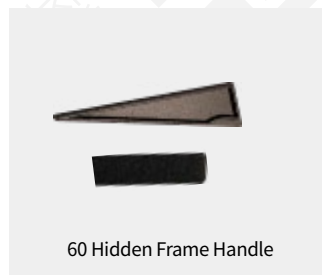

60 Hidden Frame Handle



60 Hidden Frame Handle



615 frameless glass profiles

Product configuration

Advantage: no need for 45 degree machine

Right angle design can be operated by a small machine without angle code connection

PROFILE

615 无框玻璃门

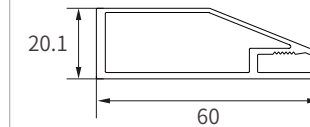

8支/包

Weight: 0.703Kg/m thickness: 2.4mm

HARDWARE FUNCTIONAL PARTS



615 Frameless Cover:Frameless on 3 sides



Straight, medium and large bend hinges

Disc manual cutter





MINIMALIST PROFILE (HINGE FREE / 20 FRAMES EXTREMELY NARROW)

Product Configuration

Board core with: glass, less than 5 mm board
Specifications: Handle (2.6m 2.9m 5.2m 5.8m 3m)

Color: iron gray, matte black, brushed gold, leather Hermes orange, gentleman gray, grape purple, angel pink, Chinese red, pale green, pearlescent white, light gold. Bronze, onyx gray, gray curry



GLASS CABINET PROFILES

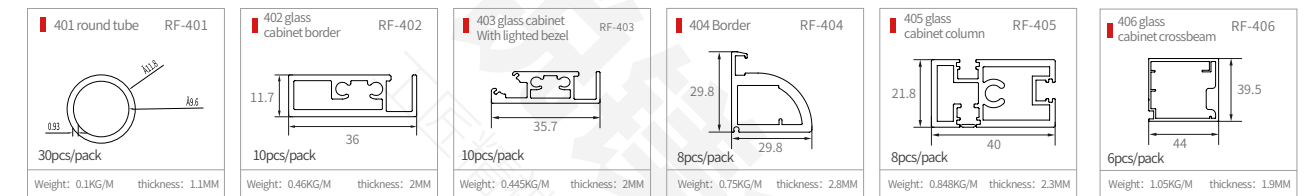

NEW QUICK RELEASE GLASS CABINET

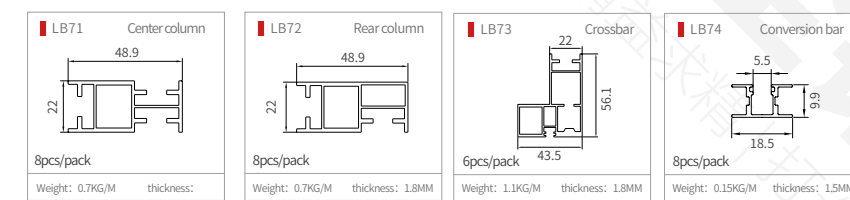

HARDWARE ACCESSORIES





LIGHTED ALUMINUM PANEL CABINET



LIGHTED ALUMINUM PANEL CABINET PROFILE

■ 280 backlight laminate (3 sheets/pack)

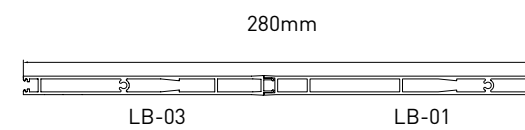

6m / 16.13kg thicknesses: 1.5MM

■ 300 with light laminate (3 sheets/pack)

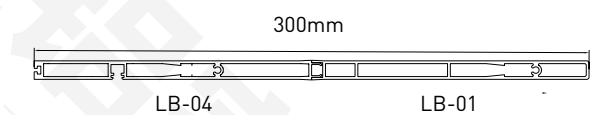

6m / 17.34kg thicknesses: 1.5MM

■ 312 side panels (3 sheets/pack)

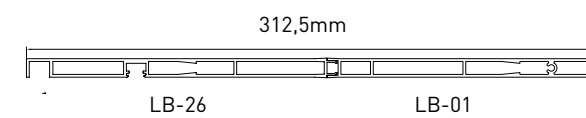

6m / 17.58kg thicknesses: 1.5MM

■ 300 risers (3 sheets/pack)

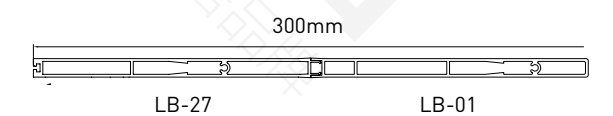

6m / 17.2kg thicknesses: 1.5MM

WALL/CEILING SERIES

Wall/ceiling series

Aluminum alloy is currently a very popular decoration material. We have multi-functional boards that can be used as a ceiling decor or wall background. As its energy saving, fire prevention, moisture resistance, sound insulation, heat preservation, heat insulation, corrosion resistance, super hardness, no deformation after scrubbing, it is becoming more and more popular in the decoration industry.

CEILING PROFILES

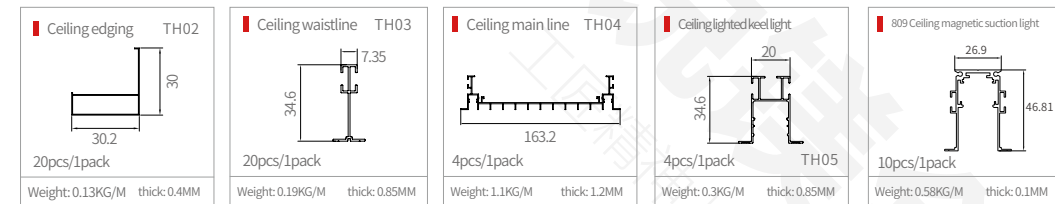

5 MM / 10 MM WALL DECOR PROFILE

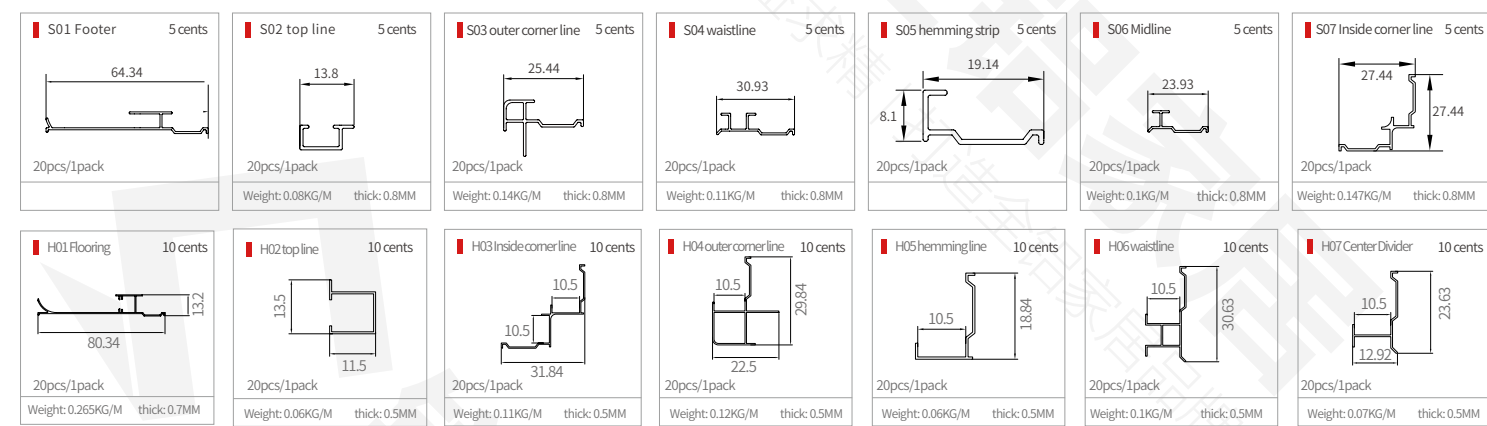

ALL ALUMINUM GRILLE/WALL DECOR SERIES

Product Description

- The overall structure of the grille cover distributes the load evenly, which helps the grille installation and its installation support structure to be evenly stressed.
- The glossy surface of the grating and the inclined body grating surface make the grating self-cleaning.

PROFILE

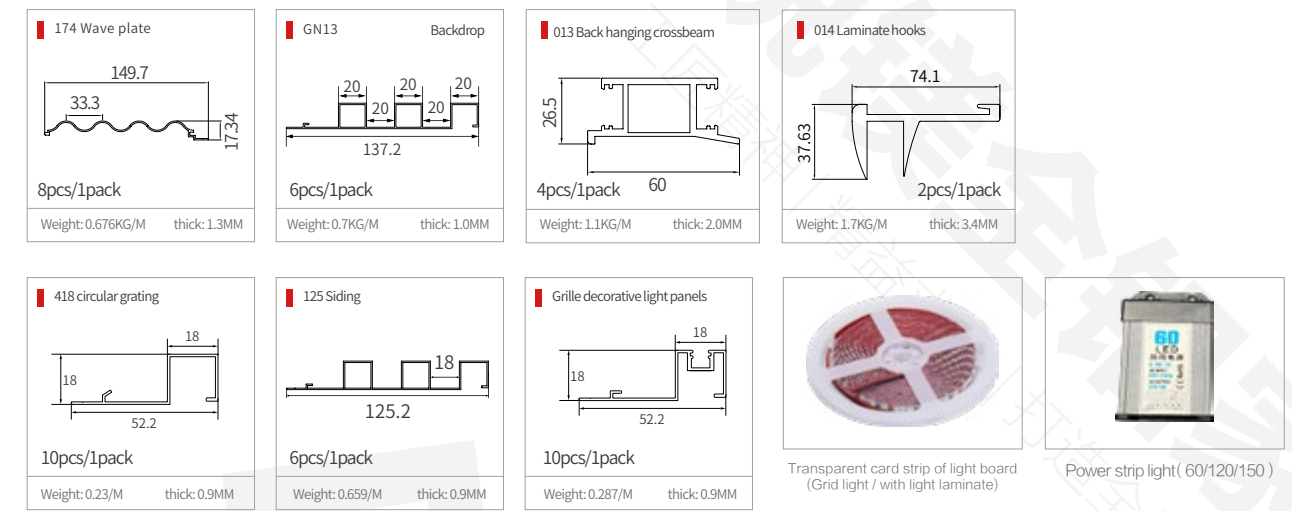

ALUMINUM HOUSEHOLD SERIES CUSTOMIZED SYSTEM



Global Selection
Careful selection
of materials



Aldehyde-free
Protect your health



All-aluminum frame
Structural stability



Customization
Healthy Home



Cabinet Series ●●●●

CABINET SERIES

It is the pious pursuit of modern living room, simple body and perfect texture.
We are longing for the perfection of the next work. You and I deserve to look forward to.



GIFT OF NATURE

Early in the morning, a ray of sunlight shines straight into the room, like a bunch of bright and shining golden threads, which not only light up the room, but also light up my heart.

The sunlight is warm and fresh and natural. Whenever a ray of sunshine sprinkles on the windowsill, I hold this gift of nature with both hands and savor the beauty of sunshine. The sunshine is so beautiful.



Internal functions will not be limited by external design. You can use these door cabinets to create a quiet and streamlined appearance, while ensuring that there are countless neat and orderly storage combinations inside. Customization is so flexible and attractive.





Customized Design / Make a Difference

No amount of space should prevent you from making it your favorite corner. Customize for flexible storage.

HOME

ULTIMATE QUALITY WITH A BIG DIFFERENCE



HIGHLY WEATHERPROOF ALL-ALUMINUM MANUFACTURING

Wear resistance and pressure resistance, thick materials, corrosion and penetration resistance, durable

WARDROBE SERIES

It is a devout pursuit of modern living, with a minimalist form and perfect texture, We are eager for the perfection of our next work, and both of us are worth looking forward to.



We know that decorating your first apartment may be a bit difficult. To make it easier for you, you can customize your furniture combination with simple classic designs that never tire of. Paired with decorations and comfortable textiles, you can immediately have a fully functional and stylish home.





Customized Design / Make a Difference

No amount of space should prevent you from making it your favorite corner. Customize for flexible storage.

HOME

ULTIMATE QUALITY WITH A BIG DIFFERENCE





Internal functions will not be limited by external design. You can use these door cabinets to create a quiet and streamlined appearance, while ensuring that there are countless neat and orderly storage combinations inside. Customization is so flexible and attractive.



WINE CABINET SERIES

LUXURIA NISM



彰显可持续环保理念，同时又不失时尚和耐看设计，为你的家增添一抹自然气息；造型门板突显书柜的俐落线条，呈现出开放通透、现代时尚的外观。

Highlight the concept of sustainable environmental protection, while not losing fashion and durable design, adding a touch of natural flavor to your home; The modeling door panel highlights the neat lines of the bookcase, presenting an open, transparent, modern and fashionable appearance.



HOME

Customized Design
Make a Difference

No amount of space should prevent you from making it your favorite corner. Customize for flexible storage.

ULTIMATE QUALITY WITH A BIG DIFFERENCE



TATAMI SERIES



BEAUTIFUL SHAPE, AS IN A SONG; THE COLOR AND TEXTURE OF THE SUPERIOR COMBINATION OF STYLISH, SIMPLE QUALITY; EXQUISITE FURNISHINGS, MORE LET A PERSON BE GOOD TO HEAR OR SEE, FRIENDLY EASY. MAKE YOUR LIFE MORE COMFORTABLE, QUIET, COMFORTABLE!



ENHANCE
ADVANCED SENSE OF SPACE

Storage boxes with compartments help you keep your accessories organized and easy to find, perfect for spacious drawers! Door cabinets provide stylish and dust-free storage!



Internal functions will not be limited by external design. You can use these door cabinets to create a quiet and streamlined appearance, while ensuring that there are countless neat and orderly storage combinations inside. Customization is so flexible and attractive.



Customized Design / Make a Difference

No amount of space should prevent you from making it your favorite corner. Customize for flexible storage.

HOME

ULTIMATE QUALITY WITH A BIG DIFFERENCE

BOOK CABINET SERIES



BEAUTIFUL SHAPE, AS IN A SONG; THE COLOR AND TEXTURE OF THE SUPERIOR COMBINATION OF STYLISH, SIMPLE QUALITY; EXQUISITE FURNISHINGS, MORE LET A PERSON BE GOOD TO HEAR OR SEE, FRIENDLY EASY. MAKE YOUR LIFE MORE COMFORTABLE, QUIET, COMFORTABLE!



LUXURIA NISM



Highlight the concept of sustainable environmental protection, while not losing fashion and durable design, adding a touch of natural flavor to your home; The modeling door panel highlights the neat lines of the bookcase, presenting an open, transparent, modern and fashionable appearance.

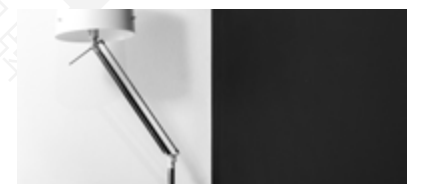



CUSTOM DESIGN

Noble and elegant modeling, soft and wonderful touch, so that you become comfortable and natural.
 yesterday's infinite glory, tomorrow's brilliant again.
 Let you in the elegant living room interpretation of today's classic fashion new modeling design, the perfect use
 of space, highlighting the function.
 Perfect use of space, highlighting the function.



TV CABINET SERIES

We can't find the remote control for you, but we can provide you with a place to put the remote control (or all other similar items). Most TV cabinets are equipped with shelves, drawers or lockers, and have a spacious top space, which can facilitate you to store all kinds of items



Internal functions will not be limited by external design. You can use these door cabinets to create a quiet and streamlined appearance, while ensuring that there are countless neat and orderly storage combinations inside. Customization is so flexible and attractive.



Internal functions will not be limited by external design. You can use these door cabinets to create a quiet and streamlined appearance, while ensuring that there are countless neat and orderly storage combinations inside. Customization is so flexible and attractive.



Highlight the concept of sustainable environmental protection, while not losing fashion and durable design, adding a touch of natural flavor to your home; The modeling door panel highlights the neat lines of the bookcase, presenting an open, transparent, modern and fashionable appearance.



HIGHLY WEATHERPROOF ALL-ALUMINUM MANUFACTURING

Wear resistance and pressure resistance, thick materials, corrosion and penetration resistance, durable



SHOE CABINET SERIES

Internal functions will not be limited by external design. You can use these door cabinets to create a quiet and streamlined appearance, while ensuring that there are countless neat and orderly storage combinations inside. Customization is so flexible and attractive.





CUSTOM DESIGN

Noble and elegant modeling, soft and wonderful touch, so that you become comfortable and natural.

yesterday's infinite glory, tomorrow's brilliant again.

Let you in the elegant living room interpretation of today's classic fashion new modeling design, the perfect use

of space, highlighting the function.

Perfect use of space, highlighting the function.

BALCONY CABINET SERIES

Elegant shape, all in the millimeter curve; superior combination of color and material, showing the quality of fashion and simplicity; exquisite furnishings, more pleasing to the eye, friendly and relaxed. Make your life more warm, quiet and comfortable!





No amount of space should prevent you from making it your favorite corner. Customize for flexible storage.w

HOME



MIXED PAINT

No amount of space should prevent you from making it your favorite corner. Customize for flexible storage.w

NEW TREND

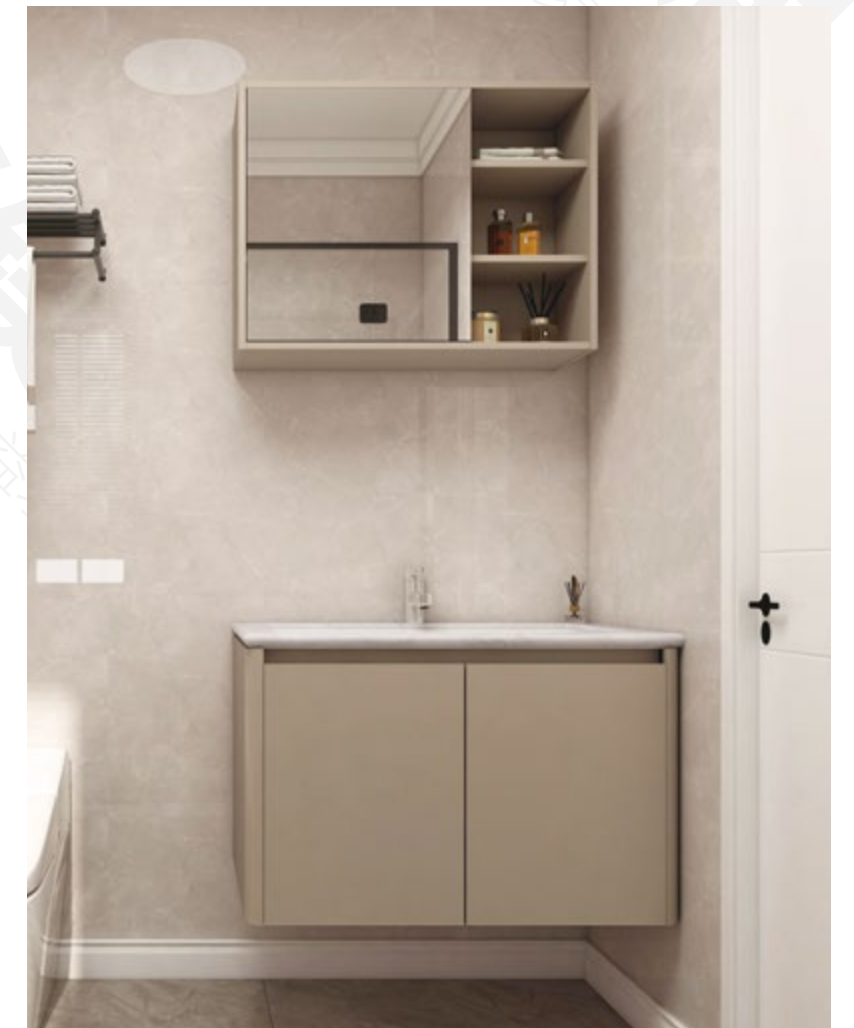

ALUMINUM DOOR SERIES

EXTRAORDINARY INGENUITY

All-aluminum interior door profiles are light-weight, strong and durable, with high-strength outer frame stabilizing properties. Compared with wooden doors, it is more corrosion-resistant, not easy to deform and decay. The oxidized coloring layer will not peel off, colorfast and durable. And it is moisture-proof and fire-proof, has good sound insulation effect, never rusts, prevents termites and insects, is healthy and environmentally friendly. Thus, it is more popular in market and it is an ideal choice for interior decoration.

Custom design



PKM-01



PKM-02



PKM-03



PKM-04



PKM-05

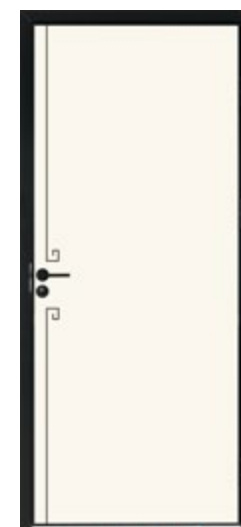

PKM-11

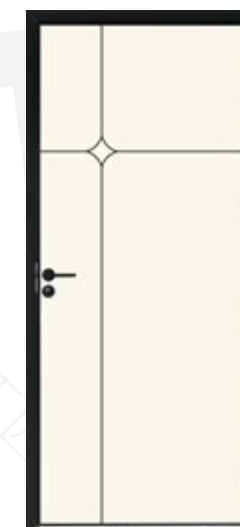

PKM-12



PKM-13



PKM-14



PKM-06



PKM-07



PKM-08



PKM-09



PKM-10



PKM-15



PKM-15

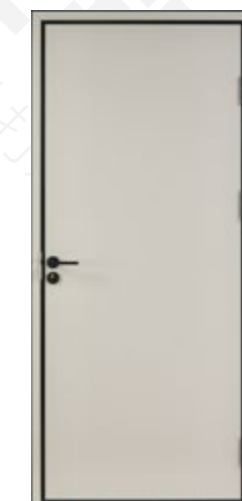

PKM-16



PKM-18

➤ DOOR PANEL SERIES



Model: GH001 door frame Door core: 80 wide arc card 1cm
 Model: GH001 door frame Door core: 10 miles gold edge aluminum strip
 Model: GH001 door frame (small louvers) Door core: NS1004 louvered aluminum
 Model: BB03 door frame Door core: double round louvers
 Model: BB03 door frame Door core: 60 wide plane card 1cm
 Model: 32/36 outer frame Door core: GH001 door frame card



Model: NS0016 door frame Door core: 10cm Mediterranean aluminum strip
 Model: NS0016 door frame Door core: card MK01 to 4 cent slot
 Model: BB036 door frame Door core: 70 wide plane card 1cm
 Model: NS0016 door frame Door core: 60 wide plane card 1cm
 Model: NS1001 door frame Door core: 70 wide plane card 4cm
 Model: NS1103 door frame Door core: 60 wide arc card 1cm



Model: NS1103 door frame Door core: 60 wide plane card 1cm
 Model: GH008 door frame Door core: 100 wide plane card 1cm
 Model: YT019 door frame Door core: card 10 percent board
 Model: HP046 door frame Door core: 80 wide plane card 1cm
 Model: NS1103 door frame Door core: GH0185 small grid
 Model: NS1005 door frame Door core: 88 wide plane card 1cm



Model: GH009 door frame Door core: 95 wide plane card 1cm
 Model: GH023 door frame (Mediterranean) Door core: 70 wide plane card 1cm
 Model: LL02 hidden frame door Door core: door core card 16% board
 Model: A03 door frame Door core: card 4 cm board + A10 square breathable board
 Model: YT0011 door frame Door core: 70 wide plane 1cm
 Model: A30 door frame Door core: card 5% board



Model: No hinge hole minimalist door Door core: 5% board/glass
 Model: round handle minimalist door Door core: 5% board/glass
 Model: thumbtack handle minimalist doors Door core: 5% board/glass
 Model: U-pull minimalist door Door core: 5% board/glass
 Model: 60 right angle beveled edge door Door core: card 5 percent board / glass
 Model: 60 right angle beveled edge door Door core: card 5 percent board / glass

➤ DOOR PANEL SERIES

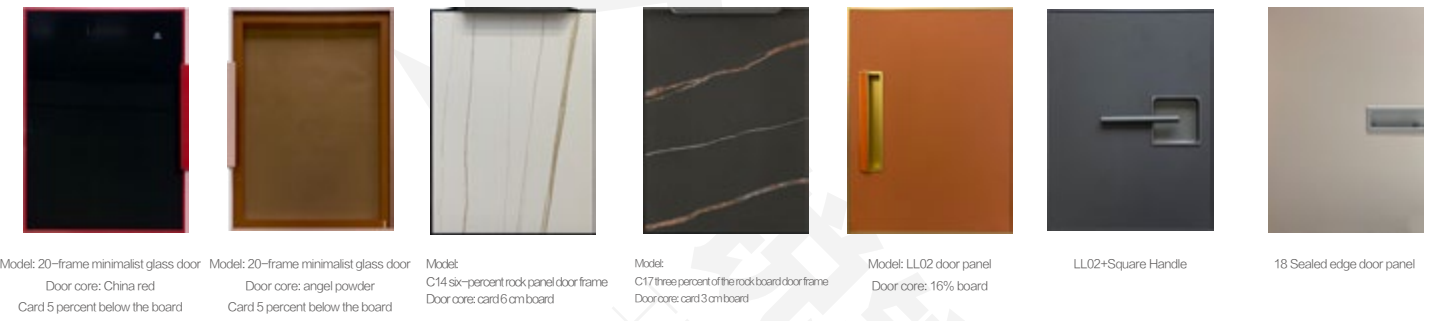

Model: 20-frame minimalist glass door Door core: China red Card 5 percent below the board
 Model: 20-frame minimalist glass door Door core: angel powder Card 5 percent below the board
 Model: C14 six-percent rock panel door frame Door core: card 6 cm board
 Model: C17 three percent of the rock board door frame Door core: card 3 cm board
 Model: LL02 door panel Door core: 16% board
 LL02+Square Handle
 18 Sealed edge door panel



18 Sealed edge door panel
 18 Sealed edge door panel
 Model: A06 door frame Door core: card 5 percent board or glass
 LL02+Half Round Handle
 Model: 18 board hidden edge frame Seal the same color sealing strip
 Model: three-sided frameless glass door Door core: 5% glass and 5% board
 Model: A03 door frame Door core: card 5 percent board or glass

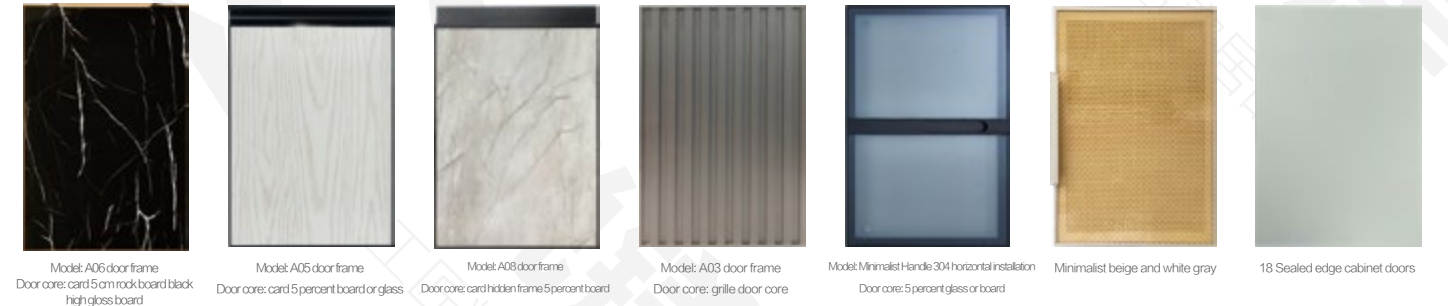

Model: A06 door frame Door core: card 5 cm rock board black high glass board
 Model: A05 door frame Door core: card 5 percent board or glass
 Model: A08 door frame Door core: card hidden frame 5 percent board
 Model: A03 door frame Door core: grille door core
 Model: Minimalist Handle 304 horizontal installation Door core: 5 percent glass or board
 Minimalist beige and white gray
 18 Sealed edge cabinet doors

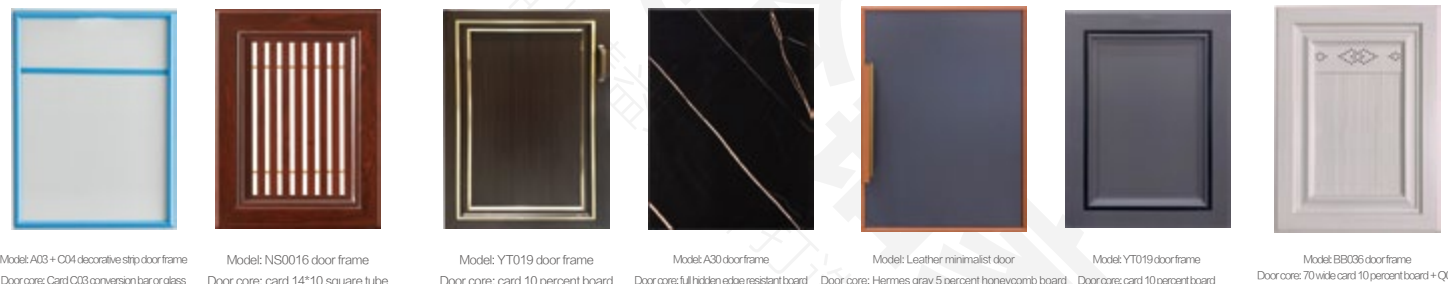

Model: A03+C04 decorative strip door frame Door core: Card C03 conversion bar or glass
 Model: NS0016 door frame Door core: card 14*10 square tube
 Model: YT019 door frame Door core: card 10 percent board
 Model: A30 door frame Door core: full hidden edge resistant board
 Model: Leather minimalist door Door core: Hermes gray 5 percent honeycomb board
 Model: YT019 door frame Door core: card 10 percent board
 Model: BB036 door frame Door core: 70 wide card 10 percent board + Q01 breathable board



Model: A06 door frame Door core: 5% board
 Model: Leather minimalist door Door core: Hermes orange 5 percent honeycomb board
 Model: Minimalist thin section F pull handle Door core: leather Hermes orange
 Model: NS1001 door frame Door core: card below 5 percent board
 Model: GH023+GH024 Card strip door frame Door core: card 10% board
 Model: NS0016 door frame Door core: 15*8 grid strip
 Model: Leather minimalist door Door core: Hermes orange

➤ CERAMIC ALUMINUM ALLOY CABINET/ACCESSORIES SERIES

| | | | |
|--|---|---|---|
| | | | |
| Weight: 0.25kg/m Wall thickness: 0.8mm Model: NC-01 Name: Master Column | Weight: 0.27kg/m Wall thickness: 0.8mm Model: NC-02 Name: Tee column | Weight: 0.22kg/m Wall thickness: 0.8mm Model: NC-03 Name: Cylindrical | Weight: 0.17kg/m Wall thickness: 0.8mm Model: NC-04 Name: Laf/Pallet |
| | | | |
| | | | |
| Weight: 0.38kg/m Wall thickness: 0.8mm Model: NC-05 Name: L-shaped door panel | Weight: 0.25kg/m Wall thickness: 0.8mm Model: NC-06 Name: Drawer/Basket | Weight: 0.07kg/m Wall thickness: 0.8mm Model: NC-07 Name: U-shaped edge banding column | Weight: 0.188kg/m Wall thickness: 0.8mm Model: NC-08 Name: Corner column |
| | | | |
| | | | |
| Weight: 0.12kg/m Wall thickness: 0.8mm Model: NC-10 Name: Connection column | Weight: 0.158kg/m Wall thickness: 0.8mm Model: NC-11 Name: Edge banding column | Cabinet feet | Crystal steel door hinge ring |
| | | | Large column gaskets |
| | | | |
| Top left joint(new) | Upper right joint(new) | Top left joint | Upper right joint |
| | | | |
| Large lower 4-way tee | Large lower 3-way tee | Large upper 3-way tee | Large upper 4-way tee |
| | | | |
| Large corner joint | 4-way tee | 3-way tee | Corner joint |
| | | | |
| Turning joint | | | |

➤ ALL-ALUMINUM MINIMALIST DOOR ACCESSORY SERIES (24 COLORS AVAILABLE)

| | | | | | | | | |
|--|---|---|---|--|---|--|---|-------------------|
| | | | | | | | | |
| brushed gold | steel-gray | Gray coffee color | 301 Lightning 20 Puller | Lightning puller | Leather Hermes Orange | Leather Hermes Gray | Matte Black | caffeine |
| | | | | | | | | |
| Angel powder | Pearlescent white | grayish purple color | Agate Gray | bronze | Cangling Green | China Red | pale gold | |
| | | | | | | | | |
| 42 Minimalist No-Pull Bezel(Matte Black) | 42 Minimalist No-Pull Bezel (brushed gold) | 60 Right Angle Beveled Edge Door/60 Top and Bottom Edge(Matte Black) | 60 Hidden Frame Handle (Matte Black) | 0.2 Minimalist Small Pull (Matte Black) | 0.2 Minimalist Small Pull (gold color) | Gentleman's Leather Gray Handle 200/1000mm | Leather Hermes Orange Handle 200/1000mm | |
| | | | | | | | | |
| Minimalist 20 Pull Handle (Iron Gray, Matte Black, Brushed Gold) One pc have 8 350 One pc have 7 350 One pc have 6 450, or 500 one pc have 5 600 One pc have 3 1000 1800/2600/2900 | A06 Handle (Matte Black/Brushed Gold) One pc have 8 350 One pc have 7 350 one pc have 6 450, or 500 one pc have 5 600 One pc have 3 1000 one pc have one 2900 | C17 Three-Centimeter Slate Handle (Matte black/brushed gold) One pc have 8 350, One pc have 7 400 One pc have 6 450-500 One pc have 5 550-600 One pc have 3 1000 | C14 Six-Centimeter Slate Handle (Matte black/brushed gold) One pc have 8 350, One pc have 7 400 One pc have 6 450-500 One pc have 5 550-600 One pc have 3 1000 | 20 Frame Minimalist Adhesive Strips | 20 Frame Minimalist Hinge Gold/Black (Medium Bend, Straight Bend, Large Bend) | No-punch hinge (Big Bend/Straight Bend/ Medium Bend) | | |
| | | | | | | | | |
| Minimalist and quick installation of stator | stator (minimalist) | Minimalist zinc alloy corner stator | Minimalist Zinc Alloy Corner Guard | Phillips Minimalist Screws Matte Black/Gold (Stainless Steel/iron) | (215 hex) Minimalist Screw Black/Gold | unpunched screw | Hinge-free stator | Hinge-free stator |

ALUMINUM CABINET

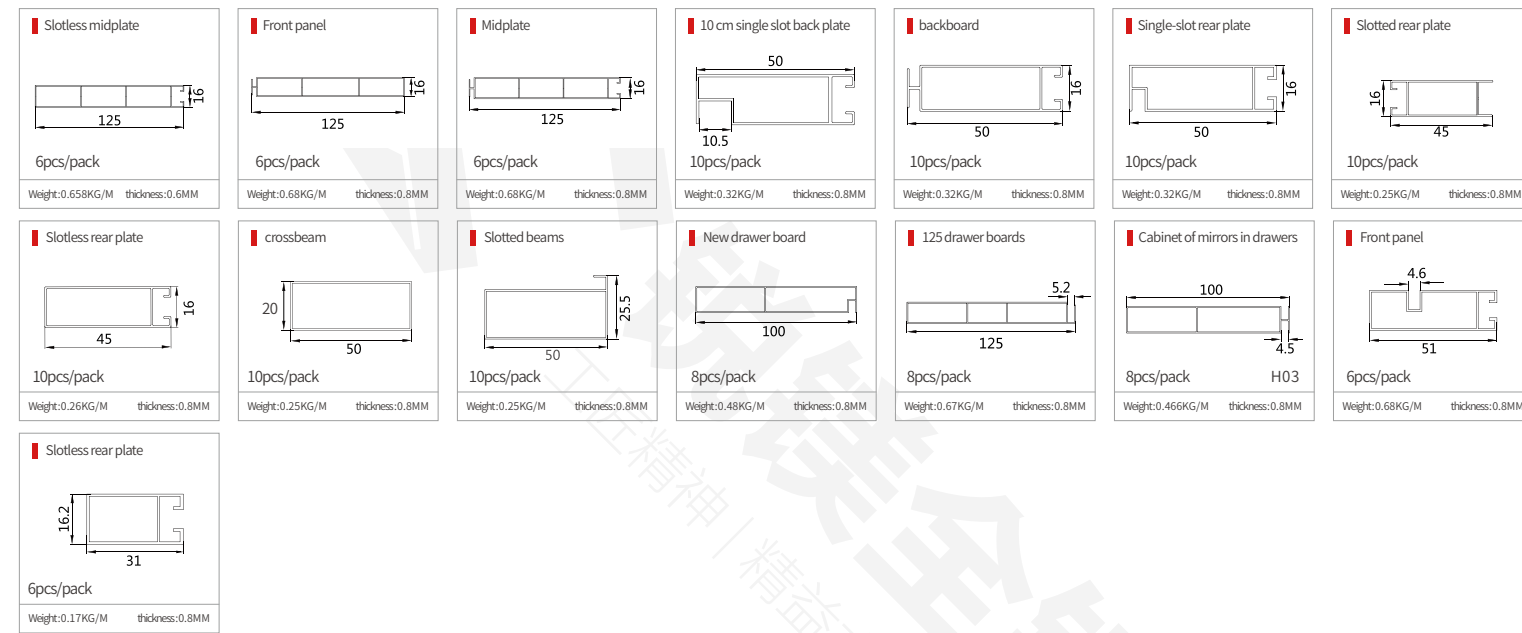

ALUMINUM SIMPLE CABINET

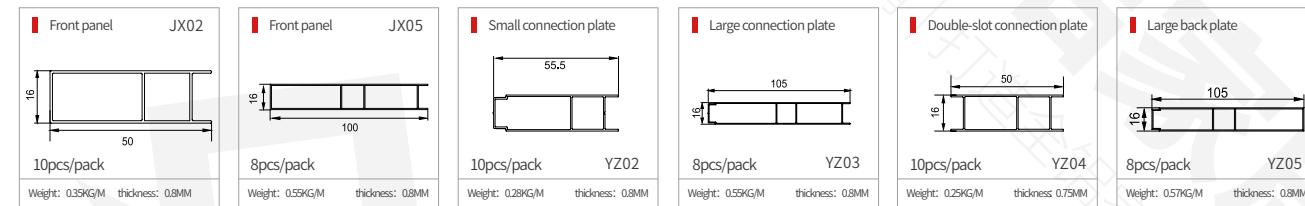

WHOLE PLATE PROFILE

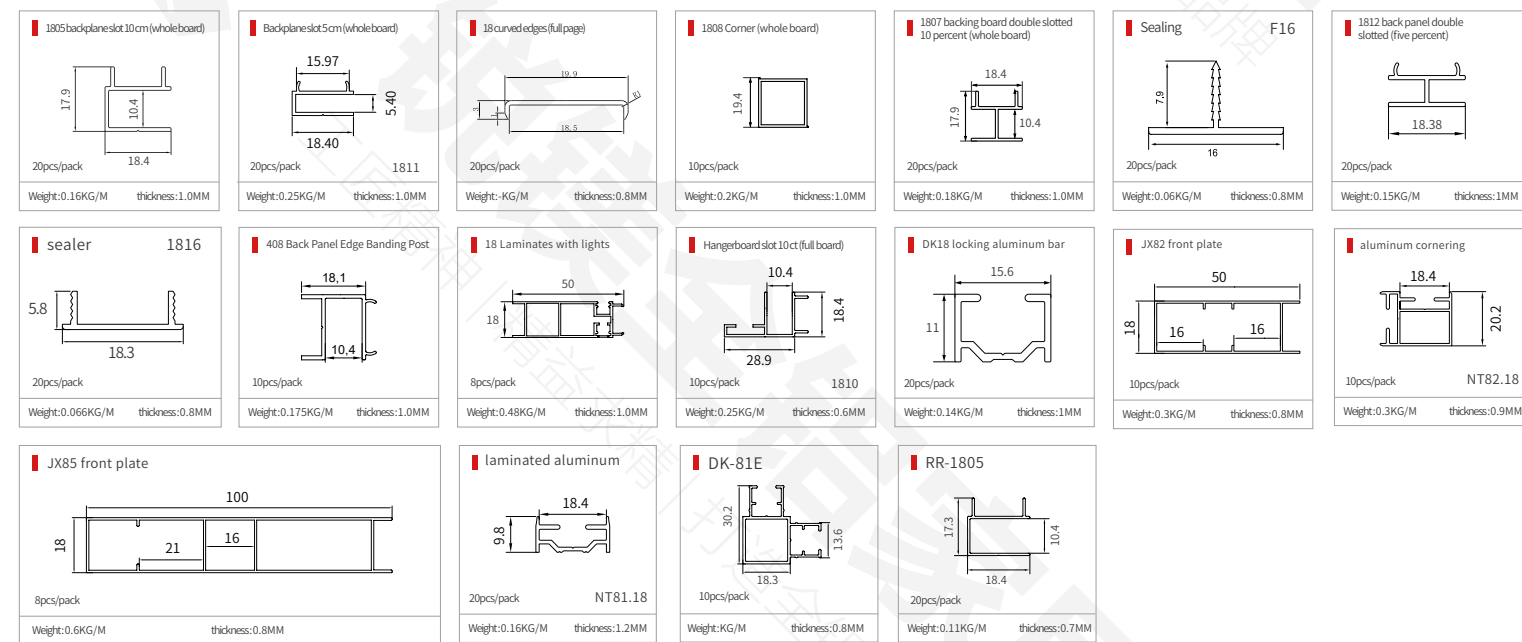

MINIMALIST PROFILE

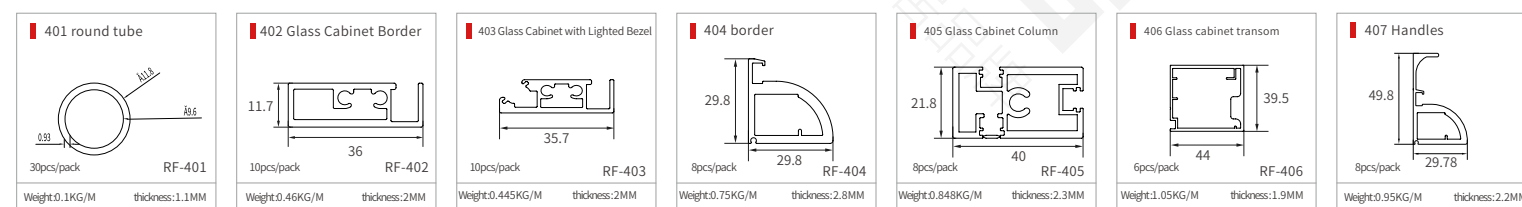

MINIMALIST PROFILE

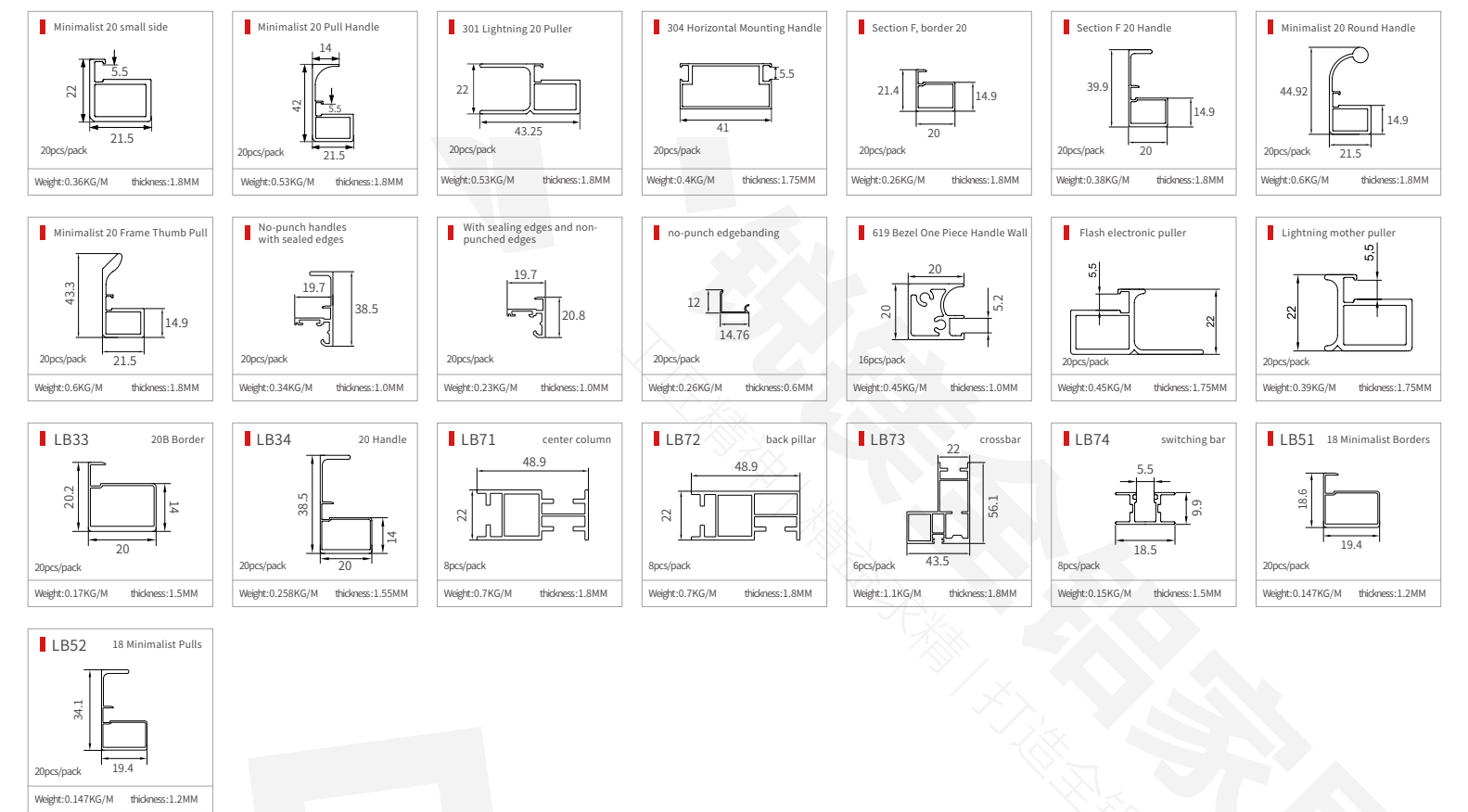

ALUMINUM PANEL CABINET PROFILE

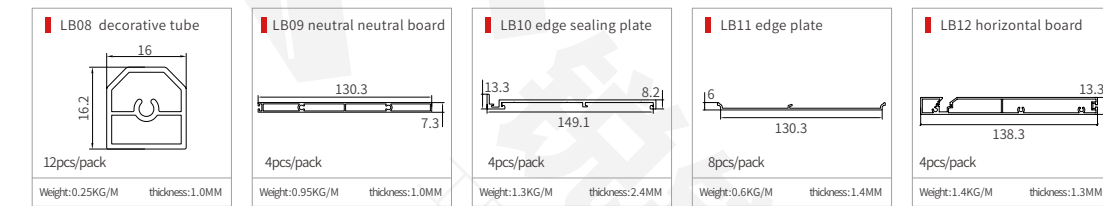

ALUMINUM SKIRTING (SILVER, ROSE GOLD, CHAMPAGNE GOLD, GENTLEMAN'S GRAY, BLACK, RUSTIC GOLD)



Footer Accessories



Snap Foot Fittings



ALUMINUM EUROPEAN DOOR/OUTER FRAME DOOR

| | | | | |
|---|---|---|---|---|
| <p>Large mirror door frame</p> <p>10pcs/pack M309 Weight: 0.33KG/M thickness: 0.8MM</p> | <p>Mediterranean/Woodgrain</p> <p>10pcs/pack GH023 Weight: 0.25KG/M thickness: 0.8MM</p> | <p>60 wide flat door frame</p> <p>10pcs/pack BB03 door frame Weight: 0.32KG/M thickness: 0.8MM</p> | <p>60 wide curved door frame</p> <p>8pcs/pack NS1103 Weight: 0.28KG/M thickness: 0.8MM</p> | <p>70 wide flat door frame</p> <p>8pcs/pack BB036 Weight: 0.42KG/M thickness: 0.8MM</p> |
| <p>70 wide flat door frame card 4mm</p> <p>8pcs/pack NS1001 Weight: 0.4KG/M thickness: 0.8MM</p> | <p>80 wide flat door frame</p> <p>8pcs/pack HP046 Weight: 0.4KG/M thickness: 0.8MM</p> | <p>80 wide curved door frame</p> <p>8pcs/pack GH001 Door frame Weight: 0.42KG/M thickness: 0.8MM</p> | <p>90 wide flat door frame</p> <p>6pcs/pack NS1005 Weight: 0.43KG/M thickness: 0.8MM</p> | <p>100 wide flat door frame</p> <p>8pcs/pack GH008 Weight: 0.58KG/M thickness: 0.8MM</p> |
| <p>60 wide flat door frame</p> <p>8pcs/pack NS0016 Weight: 0.38KG/M thickness: 0.8MM</p> | <p>18-Panel Hidden Frame Handle</p> <p>20pcs/pack LL02 Weight: 0.29KG/M thickness: 1.0MM</p> | <p>18-panel hidden border</p> <p>20pcs/pack Weight: 0.2KG/M thickness: 1.0MM</p> | <p>60 Phnom Penh Gate</p> <p>8pcs/pack YT019 Weight: 0.42KG/M thickness: 0.8MM</p> | <p>frame DT01</p> <p>10pcs/pack Weight: 0.366KG/M thickness: 0.8MM</p> |
| <p>door frame A03</p> <p>10pcs/pack Weight: 0.25KG/M thickness: 0.8MM</p> | <p>door frame A04</p> <p>10pcs/pack Weight: 0.26KG/M thickness: 1.0MM</p> | <p>hidden frame doorway</p> <p>10pcs/pack LL02 Weight: 0.134KG/M thickness: 0.6MM</p> | <p>frame DT00</p> <p>10pcs/pack Weight: 0.4KG/M thickness: 0.8MM</p> | <p>door frame GH009</p> <p>6pcs/pack Weight: 0.58KG/M thickness: 0.8MM</p> |
| <p>door frame M1088 (ungenerous)</p> <p>6pcs/pack Weight: 0.36KG/M thickness: 0.5MM</p> | <p>double louvre</p> <p>10pcs/pack GA012 Weight: 0.37KG/M thickness: 0.8MM</p> | <p>four-leaf aluminum</p> <p>10pcs/pack GA014 Weight: 0.37KG/M thickness: 0.8MM</p> | <p>1cm fastener GH002</p> <p>10pcs/pack Weight: 0.41KG/M thickness: 0.8MM</p> | <p>9mm double arc buckle plate</p> <p>10pcs/pack BB04 (ungenerous) Weight: 0.35KG/M thickness: 0.5MM</p> |
| <p>4mm fastener</p> <p>20pcs/pack NS1003 Weight: 0.27KG/M thickness: 0.6MM</p> | <p>Corrugated sheet fastening</p> <p>10pcs/pack DT04 (ungenerous) Weight: 0.33KG/M thickness: 0.5MM</p> | <p>checkerboard</p> <p>20pcs/pack GH0185 Weight: 0.072KG/M thickness: 0.8MM</p> | <p>506 Grille Door Core</p> <p>8pcs/pack Weight: 0.37KG/M thickness: 0.9MM</p> | <p>NS1004</p> <p>20pcs/pack Weight: 0.138KG/M thickness: 1.0MM</p> |
| <p>8mm gold rim</p> <p>40pcs/pack YT0033 Weight: 0.012KG/M thickness: 0.8MM</p> | <p>Aluminum with 10mm groove and gold edge</p> <p>10pcs/pack GH024 Weight: 0.17KG/M thickness: 0.8MM</p> | <p>36top and bottom frames</p> <p>16pcs/pack YA04 Weight: 0.2KG/M thickness: 0.8MM</p> | <p>32top and bottom frames</p> <p>16pcs/pack FA005 Weight: 0.18KG/M thickness: 0.8MM</p> | <p>36/32Left and right frames</p> <p>20pcs/pack YA05 Weight: 0.113KG/M thickness: 0.8MM</p> |
| <p>Q01</p> <p>20pcs/pack Weight: 0.125KG/M thickness: 0.65MM</p> | <p>Turn 4mm slot MK01</p> <p>20pcs/pack Weight: 0.12KG/M thickness: 0.7MM</p> | <p>square tube 14*10</p> <p>20pcs/pack Weight: 0.13KG/M thickness: 0.6MM</p> | <p>U-shaped golden edge</p> <p>20pcs/pack YT020 Weight: 0.04KG/M thickness: 0.8MM</p> | <p>Flat door frame 55</p> <p>8pcs/pack Weight: 0.46KG/M thickness: 1.1MM</p> |
| <p>hold hands A08</p> <p>8pcs/pack Weight: 0.46KG/M thickness: 0.8MM</p> | <p>hold hands A05</p> <p>8pcs/pack Weight: 0.48KG/M thickness: 0.8MM</p> | <p>Minimalist no-pull border</p> <p>8pcs/pack Weight: 0.44KG/M thickness: 0.8MM</p> | <p>door frame C01</p> <p>8pcs/pack Weight: 0.31KG/M thickness: 0.8MM</p> | <p>6mm Rock Slab Handle</p> <p>8pcs/pack C14 Weight: 0.4KG/M thickness: 0.8MM</p> |
| <p>6mm rock slab border</p> <p>8pcs/pack C15 Weight: 0.29KG/M thickness: 0.8MM</p> | <p>3mm Rock Slab Handle</p> <p>8pcs/pack C17 Weight: 0.39KG/M thickness: 0.8MM</p> | <p>Beveled Edge Puller</p> <p>10pcs/pack A31 Weight: 0.294KG/M thickness: 0.8MM</p> | <p>full invisible border</p> <p>10pcs/pack A30 Weight: 0.247KG/M thickness: 0.8MM</p> | <p>mother hand</p> <p>10pcs/pack FM02 Weight: 0.3KG/M thickness: 0.8MM</p> |
| <p>3mm rock slab border</p> <p>8pcs/pack C18 Weight: 0.29KG/M thickness: 0.8MM</p> | <p>3mm holding hands</p> <p>8pcs/pack FM01 Weight: 0.4KG/M thickness: 0.8MM</p> | <p>016 hand in hand</p> <p>8pcs/pack Weight: 0.422KG/M thickness: 0.8MM</p> | <p>A06 hold hands</p> <p>10pcs/pack Weight: 0.334KG/M thickness: 0.8MM</p> | <p>3mm rock slab border</p> <p>8pcs/pack C18 Weight: 0.29KG/M thickness: 0.8MM</p> |

ALUMINUM EUROPEAN DOOR/OUTER FRAME DOOR

| | | | | |
|---|---|--|--|--|
| <p>Minimalist M04 Bottom Horizontal</p> <p>10pcs/pack Weight: 0.47KG/M thickness: 0.9MM</p> | <p>Minimalist M05 Handle Horizontal</p> <p>6pcs/pack Weight: 0.726KG/M thickness: 0.85MM</p> | <p>Minimalist M01 Vertical Frame</p> <p>12pcs/pack Weight: 0.38KG/M thickness: 1.0MM</p> | <p>Minimalist M02 Top Horizontal</p> <p>10pcs/pack Weight: 0.3KG/M thickness: 0.9MM</p> | <p>Minimalist M03 Horizontal</p> <p>10pcs/pack Weight: 0.33KG/M thickness: 0.9MM</p> |
| <p>D01 sliding door lower horizontal</p> <p>10pcs/pack Weight: 0.43KG/M thickness: 1.0MM</p> | <p>D03 sliding door vertical frame</p> <p>20pcs/pack Weight: 0.32KG/M thickness: 1.0MM</p> | <p>D02 sliding door up horizontal</p> <p>20pcs/pack Weight: 0.23KG/M thickness: 1.0MM</p> | <p>D04 sliding door middle horizontal</p> <p>20pcs/pack Weight: 0.23KG/M thickness: 1.0MM</p> | <p>Corrugated panel door core</p> <p>10pcs/pack Weight: 0.49KG/M thickness: 0.8MM</p> |
| <p>Three arc louvre R013</p> <p>10pcs/pack Weight: 0.47KG/M thickness: 0.75MM</p> | <p>Two slot edge arc frame</p> <p>6pcs/pack A011 Weight: 0.43KG/M thickness: 0.8MM</p> | <p>Minimalist C11 handle</p> <p>6pcs/pack Weight: 0.59KG/M thickness: 0.8MM</p> | <p>above</p> <p>20pcs/pack 045 Weight: 0.18KG/M thickness: 0.8MM</p> | <p>Below 046</p> <p>10pcs/pack Weight: 0.34KG/M thickness: 0.8MM</p> |

ALL ALUMINUM WARDROBE SLIDING DOOR PROFILE

| | | | | |
|---|--|--|---|---|
| Vertical arc box 6pcs/pack A010 Weight: 0.5KG/M thickness: 0.8MM | Use vertical frames on both sides 6pcs/pack 051 Weight: 0.44KG/M thickness: 0.8MM | Use vertical frames on both sides 6pcs/pack R051 Weight: 0.444KG/M thickness: 0.9MM | Lower track 20pcs/pack 048 Weight: 0.23KG/M thickness: 0.8MM | Upper rail 6pcs/pack 036 Weight: 0.44KG/M thickness: 0.8MM |
| Central pillar 8pcs/pack 044 Weight: 0.19KG/M thickness: 0.8MM | D06 sliding door vertical frame Spray coating 8pcs/pack oxidation 16pcs/pack Weight: 0.372KG/M thickness: 1.0MM | 5006 Edge banding 10pcs/pack Weight: 0.148KG/M thickness: 1.0MM | 157 Backplane Card Slot 10pcs/pack Weight: 0.34KG/M thickness: 1.0MM | 150 drawer board 4pcs/pack Weight: 0.84KG/M thickness: 0.8MM |



LINKING DECORATIVE PROFILES

| | | | | | |
|--|--|--|--|--|---|
| Lock buckle angle 10pcs/pack DK01AA Weight: 0.31KG/M thickness: 1.0MM | Corner aluminum 10pcs/pack NT02 Weight: 0.27KG/M thickness: 0.9MM | Lock buckle angle 10pcs/pack GT01 Weight: 0.255KG/M thickness: 0.9MM | Lock buckle layer board card strip 20pcs/pack Y75 Weight: 0.17KG/M thickness: 1.0MM | Laminated aluminum 20pcs/pack NT01 Weight: 0.15KG/M thickness: 0.9MM | Lock buckle layer board card strip 20pcs/pack LB01 Weight: 0.18KG/M thickness: 1.0MM |
| Lock aluminum strip 20pcs/pack DK06 Weight: 0.13KG/M thickness: 1.0MM | Square tube 20pcs/pack 16 Weight: 0.14KG/M thickness: 0.8MM | Wine grid half arc bar 20pcs/pack T07 Weight: 0.11KG/M thickness: 0.8MM | Wine grid 20pcs/pack T08 Weight: 0.12KG/M thickness: 0.8MM | Roman pillar 8pcs/pack 55 70 Weight: 0.42KG/M thickness: 0.8MM | Roman column card board 6pcs/pack 70 Weight: 0.6KG/M thickness: 0.8MM |
| Pressure line 6pcs/pack GH003 Weight: 0.6KG/M thickness: 0.9MM | Pressure line 4pcs/pack 80 GH031 Weight: 0.7KG/M thickness: 0.8MM | Roman pillar 10pcs/pack GH004 Weight: 0.37KG/M thickness: 0.8MM | GH-018 8pcs/pack 50 Weight: KG/M thickness: 0.8MM | Roman pillar 10pcs/pack G58 Weight: 0.37KG/M thickness: 0.8MM | Roman Pillar No. 3 10pcs/pack 55 Weight: 0.38KG/M thickness: 0.8MM |
| Decorative strip 20pcs/pack C04 Weight: 0.12KG/M thickness: 0.8MM | Decorative panel 10pcs/pack C02 Weight: 0.23KG/M thickness: 0.8MM | Sealing strip (10mm/16mm) 20pcs/pack Weight: 0.115KG/M thickness: 1.0MM | Corner card slot (10mm/16mm) 20pcs/pack Weight: 0.18KG/M thickness: 1.0MM | Laminated card slot (10mm/16mm) 20pcs/pack Weight: 0.158KG/M thickness: 1.0MM | Aluminum alloy handle 20pcs/pack Weight: 0.18KG/M thickness: 1.0MM |

LINK DECORATIVE PROFILE

| | | | | |
|--|--|---|--|---|
| Hanging clothes pole 20pcs/pack Weight: KG/M thickness: 1.0MM | Hanging clothes pole 20pcs/pack 29.4 YG01 Weight: 0.256KG/M thickness: 1.0MM | Water blocking sink countertop 8pcs/pack 52.1 BX1175 Weight: 0.38KG/M thickness: 0.8MM | Water blocking sink countertop 8pcs/pack 40 GH033 Weight: 0.28KG/M thickness: 0.8MM | Water blocking sink countertop 8pcs/pack 36 B034 Weight: 0.47KG/M thickness: 0.9MM |
| 18 baffle water retention tank 4pcs/pack 56 B044 Weight: 0.52KG/M thickness: 0.8MM | Column 8pcs/pack 31 A01 Weight: 0.43KG/M thickness: 1.0MM | Column 8pcs/pack 31 A02 Weight: 0.42KG/M thickness: 1.0MM | Corner aluminum material 6pcs/pack 50 18.5 L011 Weight: 0.7KG/M thickness: 1.0MM | Arc aluminum seal 20pcs/pack 16.2 JX06 Weight: 0.12KG/M thickness: 0.7MM |
| Arc aluminum seal 20pcs/pack 16.2 Y184 Weight: 0.115KG/M thickness: 0.8MM | Skirting line 10pcs/pack 100 Weight: 0.313KG/M thickness: 0.8MM | Grid bar 15 * 8 20pcs/pack 8 15 Weight: KG/M thickness: 0.7MM | Edge sealing 20pcs/pack 16.2 14.4 1606 Weight: 0.09KG/M thickness: 1.0MM | Backboard card slot 4mm 1607/10mm 1605 20pcs/pack 16 14.4 10.3 Weight: 0.16KG/M thickness: 1.0MM |
| RR16-05 20pcs/pack 17 91 10.4 Weight: 0.6KG/M thickness: 0.7MM | Lamp strip holder 10pcs/pack 5 35 CB35 Weight: 0.23KG/M thickness: 0.8MM | Laminated card holder 10pcs/pack 12 35 5 CB36 Weight: 0.24KG/M thickness: 0.8MM | Door frame decorative strip 20pcs/pack 10.5 055 Weight: 0.2KG/M thickness: 1MM | Decorative panel 20pcs/pack 62.2 A09 Weight: 0.16KG/M thickness: 0.5MM |
| Induction light with clamp strip 20pcs/pack 55 16 C16 Weight: 0.29KG/M thickness: 0.8MM | Light strip without handle 20pcs/pack 50 20 C20 Weight: 0.25KG/M thickness: 0.8MM | Bathroom cabinet front bumper 6pcs/pack 33 50 Weight: 0.527KG/M thickness: 0.8MM | 50 handle free crossbeam 8pcs/pack 36.5 50 Weight: 0.55KG/M thickness: 0.8MM | 50 wide front panel 6pcs/pack 50 BR371 Weight: 0.322KG/M thickness: 0.7MM |
| 18.5 sealing edge 40pcs/pack 19.3 2.7 Weight: KG/M thickness: MM | decorative strip 100pcs/pack 4.5 10 C03 Weight: 0.04KG/M thickness: 0.55MM | 10mm Decorative Strip 40pcs/pack 8.5 10.5 C10 Weight: 0.08KG/M thickness: 0.6mm | 4K18 pass sleeve 10pcs/pack 40 18.5 Weight: 0.22KG/M thickness: 1.0MM | 4K10 pass sleeve 10pcs/pack 40 10.5 Weight: 0.22KG/M thickness: 1.0MM |
| T-01 T-bar 100pcs/pack 5.5 6 Weight: 0.035KG/M thickness: 1.2MM | LB53 half-arc corner 8pcs/pack 35 96 Weight: 0.272KG/M thickness: 0.8MM | LB-2506 25 Edgebanding 20pcs/pack 25 21.2 Weight: 0.08KG/M thickness: 1.0MM | | |

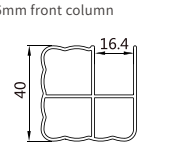
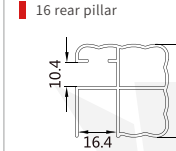
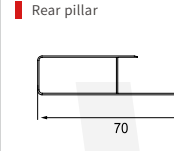
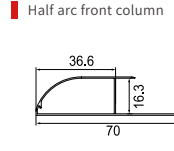
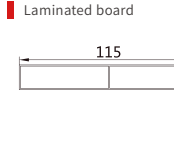
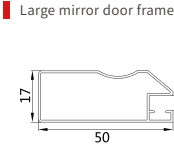
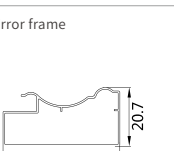
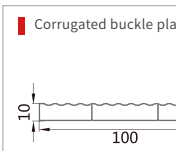
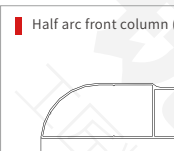

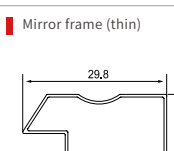
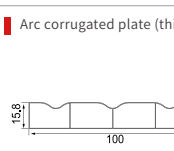
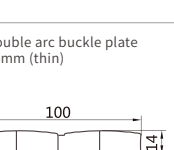
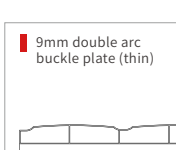
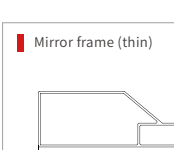
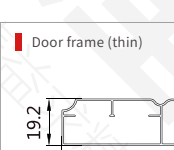
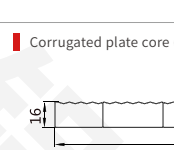
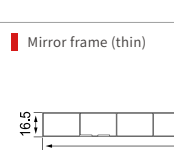
ALUMINUM BATHROOM CABINET

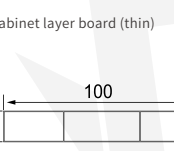
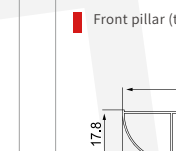
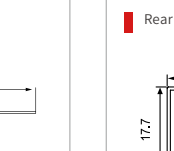
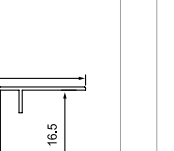
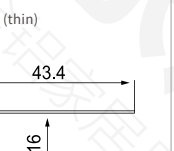
| | | | | | |
|--|--|--|--|--|--|
|  <p>16mm front column</p> <p>6pcs/pack YM003</p> <p>Weight:0.675KG/M thickness: 1.0MM</p> |  <p>16 rear pillar</p> <p>6pcs/pack YM004</p> <p>Weight:0.672KG/M thickness: 1.0MM</p> |  <p>Rear pillar</p> <p>8pcs/pack SG026</p> <p>Weight:0.3KG/M thickness: 0.7MM</p> |  <p>Half arc front column</p> <p>8pcs/pack SG027</p> <p>Weight:0.321KG/M thickness: 0.8MM</p> |  <p>Laminated board</p> <p>6pcs/pack CC01</p> <p>Weight:0.6KG/M thickness: 0.8MM</p> |  <p>Large mirror door frame</p> <p>10pcs/pack M309</p> <p>Weight:0.33KG/M thickness: 0.8MM</p> |
|  <p>Mirror frame</p> <p>10pcs/pack W153</p> <p>Weight:0.216KG/M thickness: 0.8MM</p> |  <p>Corrugated buckle plate (thin)</p> <p>10pcs/pack DT04</p> <p>Weight:0.316KG/M thickness: 0.5MM</p> |  <p>Half arc front column (thin)</p> <p>8pcs/pack K02</p> <p>Weight:0.25KG/M thickness: 0.5MM</p> |  <p>Rear pillar (thin)</p> <p>8pcs/pack K03</p> <p>Weight:0.25KG/M thickness: 0.5MM</p> |  <p>Mirror frame (thin)</p> <p>20pcs/pack M617</p> <p>Weight:0.16KG/M thickness: 0.55MM</p> |  <p>Arc corrugated plate (thin)</p> <p>8pcs/pack M611</p> <p>Weight:0.35KG/M thickness: 0.4MM</p> |
|  <p>Double arc buckle plate 14mm (thin)</p> <p>10pcs/pack LD100</p> <p>Weight:0.35KG/M thickness: 0.5MM</p> |  <p>9mm double arc buckle plate (thin)</p> <p>10pcs/pack BB04</p> <p>Weight:0.35KG/M thickness: 0.5MM</p> |  <p>Mirror frame (thin)</p> <p>20pcs/pack K01</p> <p>Weight:0.13KG/M thickness: 0.5MM</p> |  <p>Door frame (thin)</p> <p>8pcs/pack M1009</p> <p>Weight:0.25KG/M thickness: 0.42MM</p> |  <p>Corrugated plate core (thin)</p> <p>8pcs/pack K04</p> <p>Weight:0.33KG/M thickness: 0.5MM</p> |  <p>Mirror frame (thin)</p> <p>6pcs/pack X603</p> <p>Weight:0.43KG/M thickness: 0.55MM</p> |

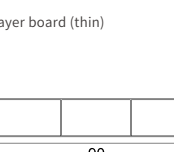
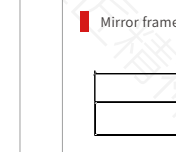
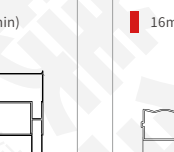
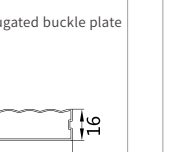

| | | | | |
|--|---|--|--|--|
|  <p>Cabinet layer board (thin)</p> <p>8pcs/pack M604</p> <p>Weight:0.33KG/M thickness: 0.4MM</p> |  <p>Front pillar (thin)</p> <p>20pcs/pack B1</p> <p>Weight:0.191KG/M thickness: 0.6MM</p> |  <p>Rear pillar (thin)</p> <p>20pcs/pack B2</p> <p>Weight:0.161KG/M thickness: 0.6MM</p> |  <p>Door edge (thin)</p> <p>20pcs/pack B3</p> <p>Weight:0.121KG/M thickness: 0.6MM</p> |  <p>New drawer board (thin)</p> <p>8pcs/pack</p> <p>Weight:0.37KG/M thickness: 0.5MM</p> |
|--|---|--|--|--|

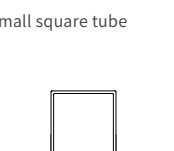
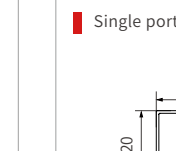
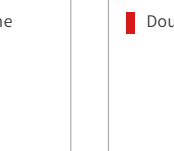
| | | | |
|--|--|---|--|
|  <p>Layer board (thin)</p> <p>8pcs/pack M618</p> <p>Weight:0.3KG/M thickness: 0.4MM</p> |  <p>Mirror frame in drawer (thin)</p> <p>8pcs/pack ZH03</p> <p>Weight:0.383 KG/M thickness: 0.4MM</p> |  <p>16mm thick corrugated buckle plate</p> <p>8pcs/pack YM002</p> <p>Weight:0.5KG/M thickness: 0.8MM</p> |  <p>18 Bathroom cabinet columns</p> <p>JX-18</p> <p>Weight:0.323KG/M thickness: 0.8MM</p> |
|--|--|---|--|

FLOWER RACK PROFILE

| | | | |
|--|--|---|---|
|  <p>Small square tube</p> <p>20pcs/pack</p> <p>Weight:0.18KG/M thickness: 0.8MM</p> |  <p>Single port small frame</p> <p>20pcs/pack</p> <p>Weight:0.22KG/M thickness: 0.8MM</p> |  <p>Double mouth small frame</p> <p>20pcs/pack</p> <p>Weight:0.26KG/M thickness: 0.8MM</p> |  <p>Laminate strip</p> <p>20pcs/pack</p> <p>Weight:0.18KG/M thickness: 0.8MM</p> |
|--|--|---|---|

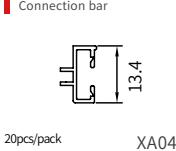
ALUMINIUM INDOOR DOOR

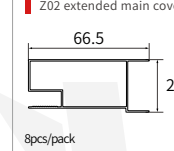
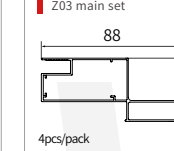
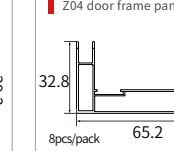
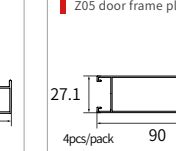
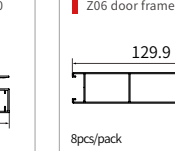
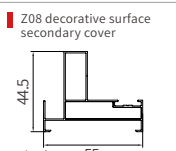
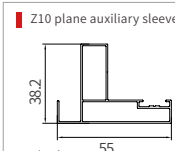
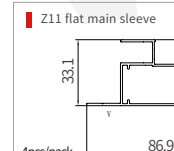
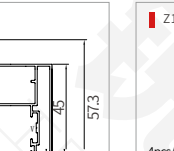
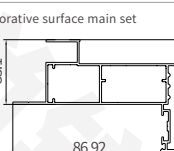
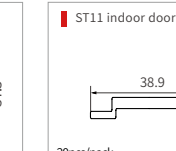
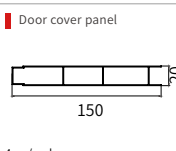
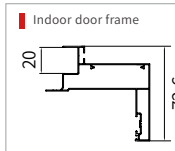
| | | | | | | |
|--|--|---|---|--|--|--|
|  <p>Connection bar</p> <p>20pcs/pack XA04</p> <p>Weight:0.08KG/M thickness: 0.8MM</p> |  <p>Z01 main sleeve gasket</p> <p>10pcs/pack</p> <p>Weight:0.4KG/M thickness: 3.7MM</p> |  <p>Z02 extended main cover</p> <p>8pcs/pack</p> <p>Weight:0.45KG/M thickness: 0.8MM</p> |  <p>Z03 main set</p> <p>4pcs/pack</p> <p>Weight:0.75KG/M thickness: 1.0MM</p> |  <p>Z04 door frame panel</p> <p>8pcs/pack</p> <p>Weight:0.48KG/M thickness: 0.8MM</p> |  <p>Z05 door frame plate 90</p> <p>4pcs/pack</p> <p>Weight:0.78KG/M thickness: 1.0MM</p> |  <p>Z06 door frame plate 130</p> <p>8pcs/pack</p> <p>Weight:1.05KG/M thickness: 1.0MM</p> |
|  <p>Z08 decorative surface secondary cover</p> <p>8pcs/pack</p> <p>Weight:0.55KG/M thickness: 0.8MM</p> |  <p>Z10 plane auxiliary sleeve</p> <p>8pcs/pack</p> <p>Weight:1.15KG/M thickness: 0.8MM</p> |  <p>Z11 flat main sleeve</p> <p>4pcs/pack</p> <p>Weight:1.05KG/M thickness: 1.0MM</p> |  <p>Z12 decorative surface main set</p> <p>4pcs/pack</p> <p>Weight:0.95KG/M thickness: 1.0MM</p> |  <p>ST11 indoor door</p> <p>20pcs/pack</p> <p>Weight:0.2KG/M thickness: 1.3MM</p> |  <p>Double layer door slot</p> <p>4pcs/pack XA01</p> <p>Weight:0.7KG/M thickness: 1.0MM</p> | |
|  <p>Door cover panel</p> <p>4pcs/pack XA02</p> <p>Weight:1.05KG/M thickness: 0.8MM</p> |  <p>Indoor door frame</p> <p>6pcs/pack XA03</p> <p>Weight:0.75KG/M thickness: 0.8MM</p> | | | | | |

WALLBOARD SERIES

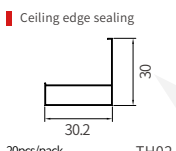
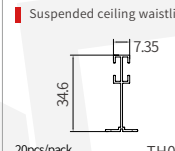
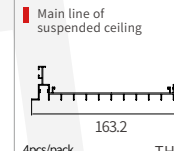
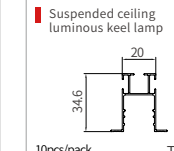
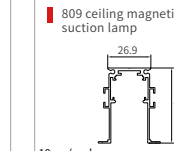
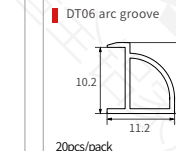
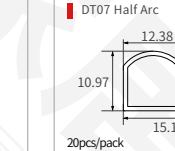
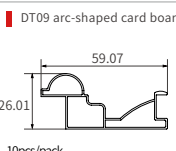
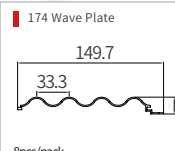
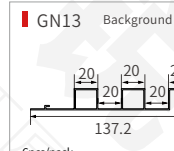
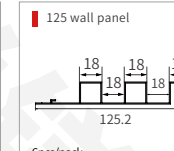
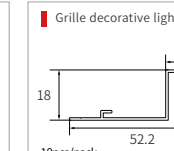
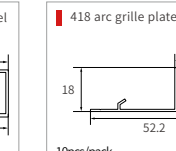
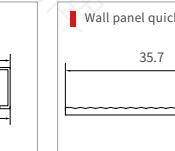
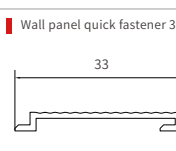
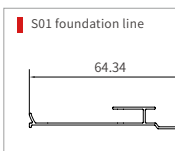
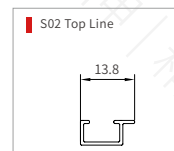
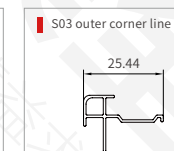
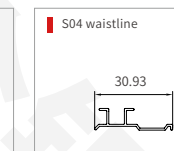
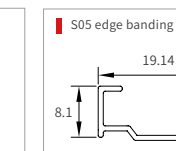
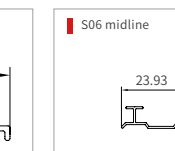
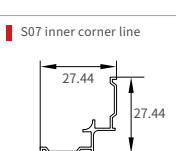
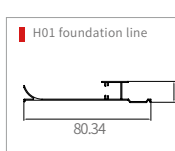
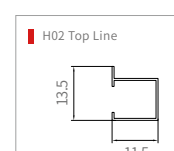
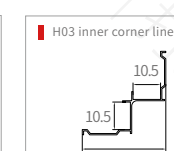
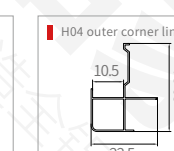
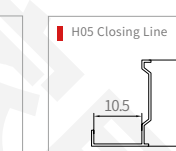
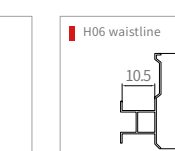
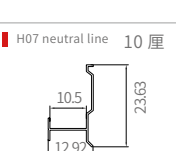
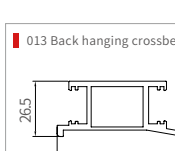
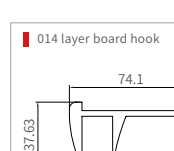
| | | | | | | |
|--|---|---|---|---|---|--|
|  <p>Ceiling edge sealing</p> <p>20pcs/pack TH02</p> <p>Weight:0.13KG/M thickness: 0.4MM</p> |  <p>Suspended ceiling waistline</p> <p>20pcs/pack TH03</p> <p>Weight:0.19KG/M thickness: 0.85MM</p> |  <p>Main line of suspended ceiling</p> <p>4pcs/pack TH04</p> <p>Weight:1.1KG/M thickness: 1.2MM</p> |  <p>Suspended ceiling luminous keel lamp</p> <p>10pcs/pack TH05</p> <p>Weight:0.3KG/M thickness: 0.85MM</p> |  <p>809 ceiling magnetic suction lamp</p> <p>10pcs/pack</p> <p>Weight:0.58KG/M thickness: 0.1MM</p> |  <p>DT06 arc groove</p> <p>20pcs/pack</p> <p>Weight:0.082KG/M thickness: 0.8MM</p> |  <p>DT07 Half Arc</p> <p>20pcs/pack</p> <p>Weight:0.8KG/M thickness: 0.097MM</p> |
|  <p>DT09 arc-shaped card board</p> <p>10pcs/pack</p> <p>Weight:0.4KG/M thickness: 0.8MM</p> |  <p>174 Wave Plate</p> <p>8pcs/pack</p> <p>Weight:0.676KG/M thickness: 1.3MM</p> |  <p>GN13 Background wall</p> <p>6pcs/pack</p> <p>Weight:0.7KG/M thickness: 1.0MM</p> |  <p>125 wall panel</p> <p>6pcs/pack</p> <p>Weight:0.659KG/M thickness: 0.9MM</p> |  <p>Grille decorative light panel</p> <p>10pcs/pack</p> <p>Weight:0.287KG/M thickness: 0.9MM</p> |  <p>418 arc grille plate</p> <p>10pcs/pack</p> <p>Weight:0.23KG/M thickness: 0.9MM</p> |  <p>Wall panel quick fastener 1</p> <p>Weight:0.17KG/M thickness: 1.5MM</p> |
|  <p>Wall panel quick fastener 3</p> <p>Weight:0.15KG/M thickness: 1.5MM</p> |  <p>S01 foundation line</p> <p>20pcs/pack</p> <p>Weight:0.23KG/M thickness: 0.8MM</p> |  <p>S02 Top Line</p> <p>20pcs/pack</p> <p>Weight:0.08KG/M thickness: 0.8MM</p> |  <p>S03 outer corner line</p> <p>20pcs/pack</p> <p>Weight:0.14KG/M thickness: 0.8MM</p> |  <p>S04 waistline</p> <p>20pcs/pack</p> <p>Weight:0.11KG/M thickness: 0.8MM</p> |  <p>S05 edge banding</p> <p>20pcs/pack</p> <p>Weight:KG/M thickness: MM</p> |  <p>S06 midline</p> <p>20pcs/pack</p> <p>Weight:0.1KG/M thickness: 0.8MM</p> |
|  <p>S07 inner corner line</p> <p>20pcs/pack</p> <p>Weight:0.147KG/M thickness: 0.8MM</p> |  <p>H01 foundation line</p> <p>20pcs/pack</p> <p>Weight:0.265KG/M thickness: 0.7MM</p> |  <p>H02 Top Line</p> <p>20pcs/pack</p> <p>Weight:0.06KG/M thickness: 0.5MM</p> |  <p>H03 inner corner line</p> <p>20pcs/pack</p> <p>Weight:0.11KG/M thickness: 0.5MM</p> |  <p>H04 outer corner line</p> <p>20pcs/pack</p> <p>Weight:0.12KG/M thickness: 0.5MM</p> |  <p>H05 Closing Line</p> <p>20pcs/pack</p> <p>Weight:0.06KG/M thickness: 0.5MM</p> |  <p>H06 waistline</p> <p>20pcs/pack</p> <p>Weight:0.1KG/M thickness: 0.5MM</p> |
|  <p>H07 neutral line 10 厘</p> <p>20pcs/pack</p> <p>Weight:0.07KG/M thickness: 0.5MM</p> |  <p>013 Back hanging crossbeam</p> <p>4pcs/pack</p> <p>Weight:1.1KG/M thickness: 2.0mm</p> |  <p>014 layer board hook</p> <p>2pcs/pack</p> <p>Weight:1.7KG/M thickness: 3.4mm</p> | | | | |

➤ ALL ALUMINUM ACCESSORIES SERIES

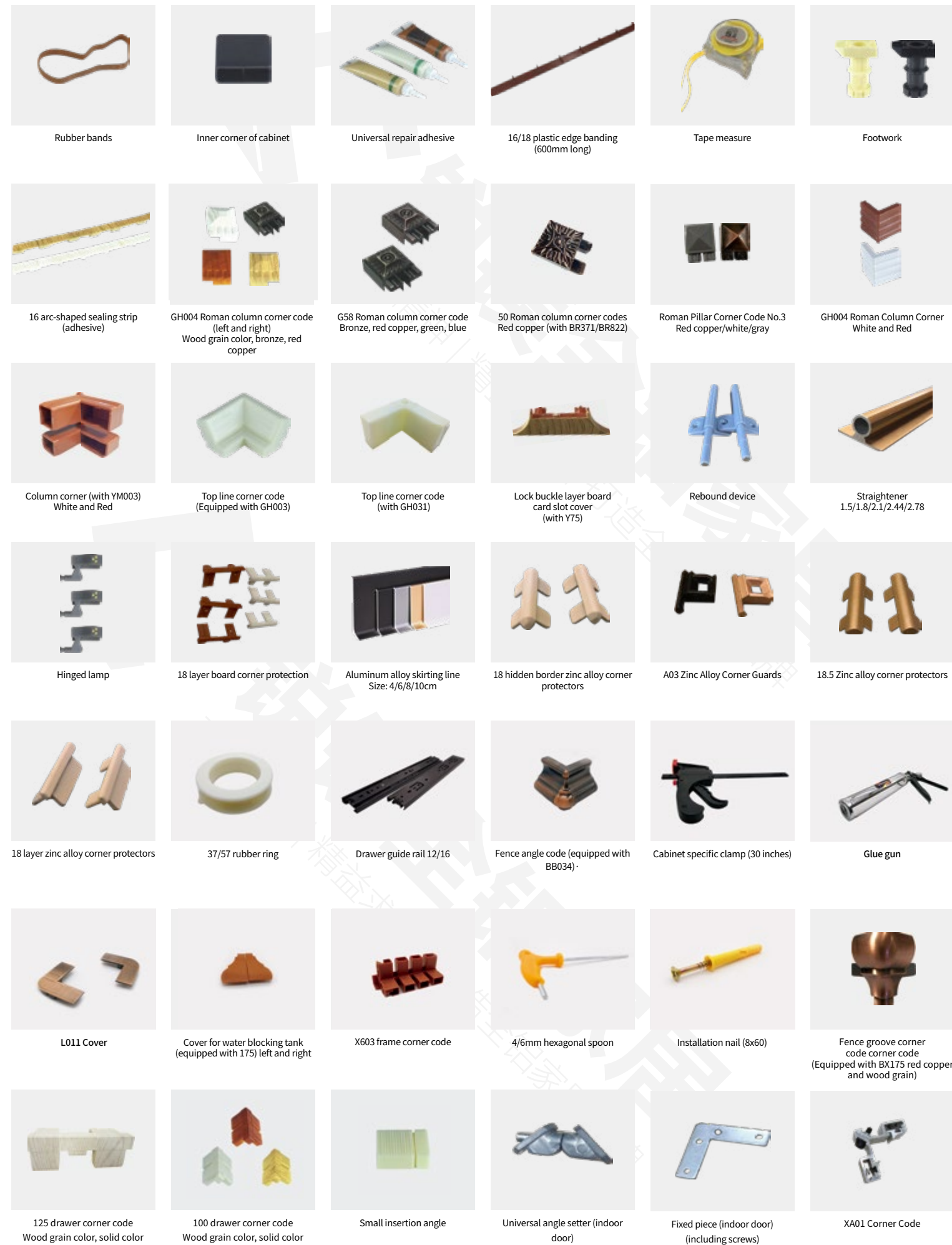

➤ ALL ALUMINUM ACCESSORIES SERIES

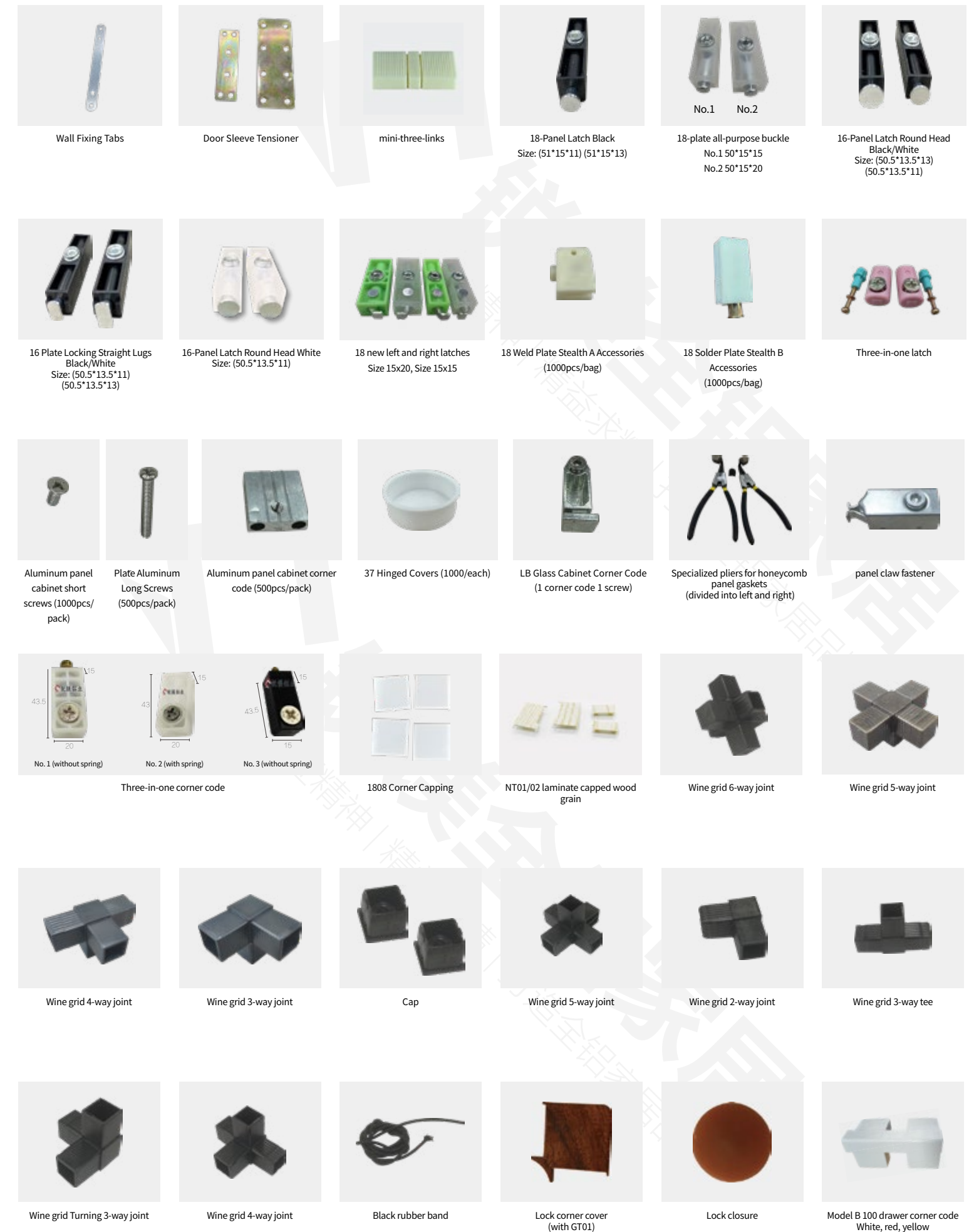

➤ ALL ALUMINUM ACCESSORIES SERIES

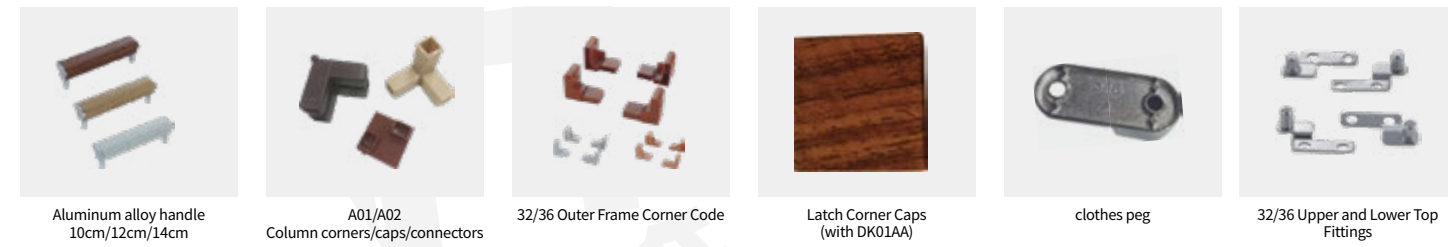

Aluminum alloy handle 10cm/12cm/14cm A01/A02 Column corners/caps/connectors 32/36 Outer Frame Corner Code Latch Corner Caps (with DK01AA) clothes peg 32/36 Upper and Lower Top Fittings

➤ 全铝门框配件系列 ALL ALUMINUM DOOR FRAME ACCESSORIES SERIES

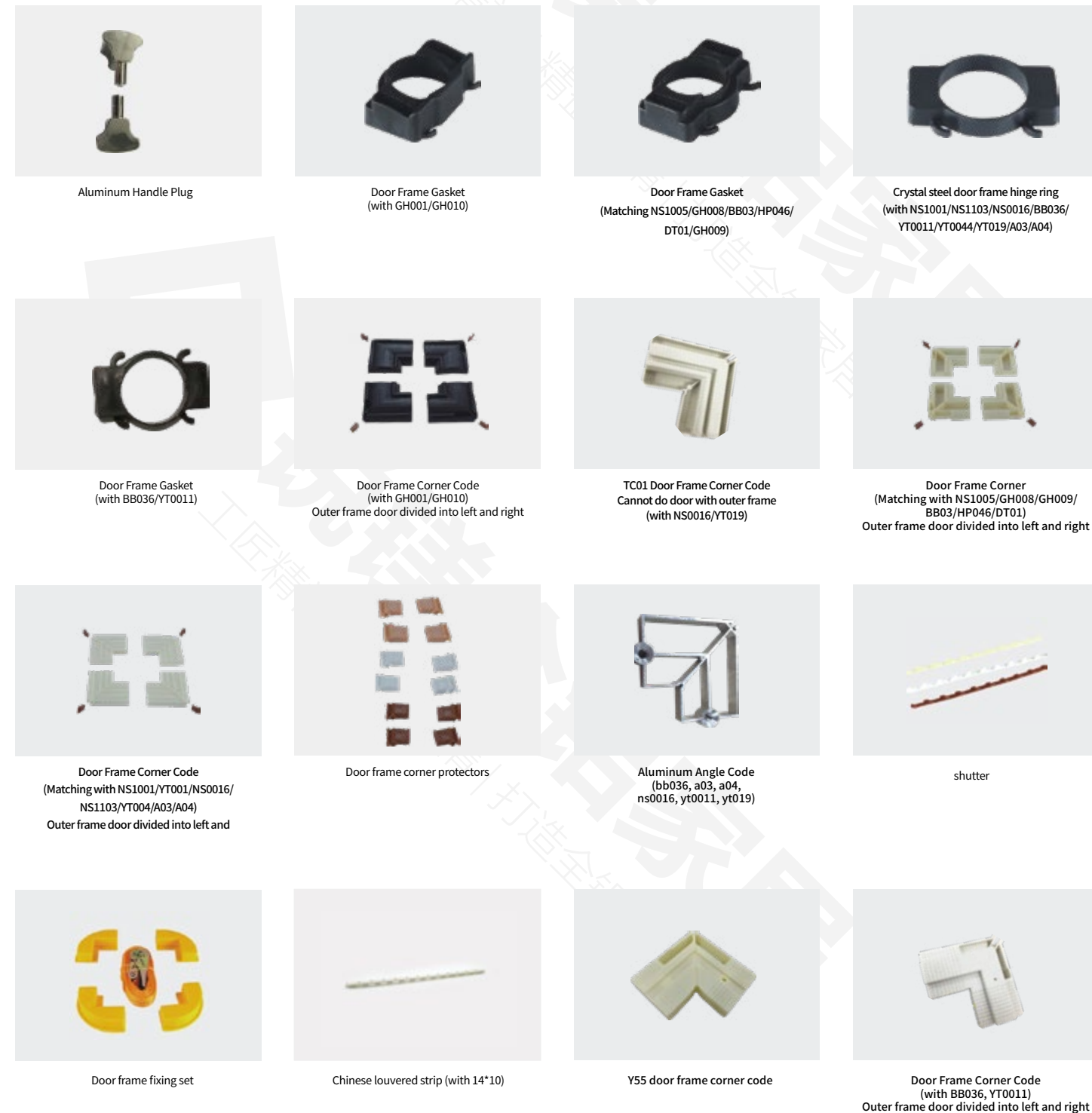

Aluminum Handle Plug Door Frame Gasket (with GH001/GH010) Door Frame Gasket (Matching NS1005/GH008/BB03/HP046/DT01/GH009) Crystal steel door frame hinge ring (with NS1001/NS1103/NS0016/BB036/YT0011/YT0044/YT019/A03/A04) Door Frame Gasket (with BB036/YT0011) Door Frame Corner Code (with GH001/GH010) Outer frame door divided into left and right TC01 Door Frame Corner Code Cannot do door with outer frame (with NS0016/YT019) Door Frame Corner (Matching with NS1005/GH008/GH009/BB03/HP046/DT01) Outer frame door divided into left and right Door Frame Corner Code (Matching with NS1001/YT001/NS0016/NS1103/YT004/A03/A04) Outer frame door divided into left and right Door frame corner protectors Aluminum Angle Code (bb036, a03, a04, ns0016, yt0011, yt019) shutter Door frame fixing set Chinese louvered strip (with 14*10) Y55 door frame corner code Door Frame Corner Code (with BB036, YT0011) Outer frame door divided into left and right

➤ ALL ALUMINUM DOOR FRAME ACCESSORIES SERIES

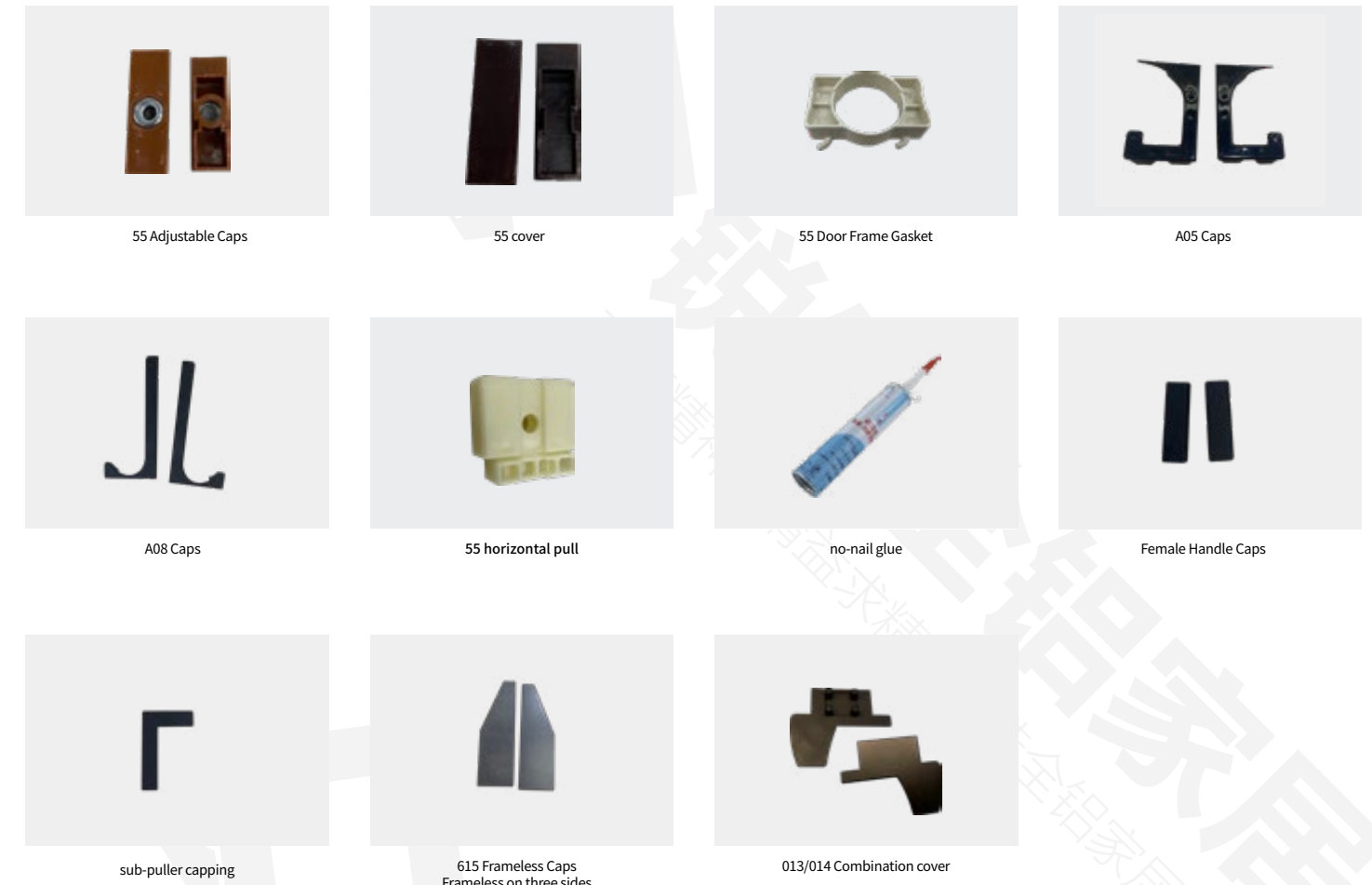

55 Adjustable Caps 55 cover 55 Door Frame Gasket A05 Caps A08 Caps 55 horizontal pull no-nail glue Female Handle Caps sub-puller capping 615 Frameless Caps Frameless on three sides 013/014 Combination cover

➤ ALL ALUMINUM DOOR PANEL HANDLE

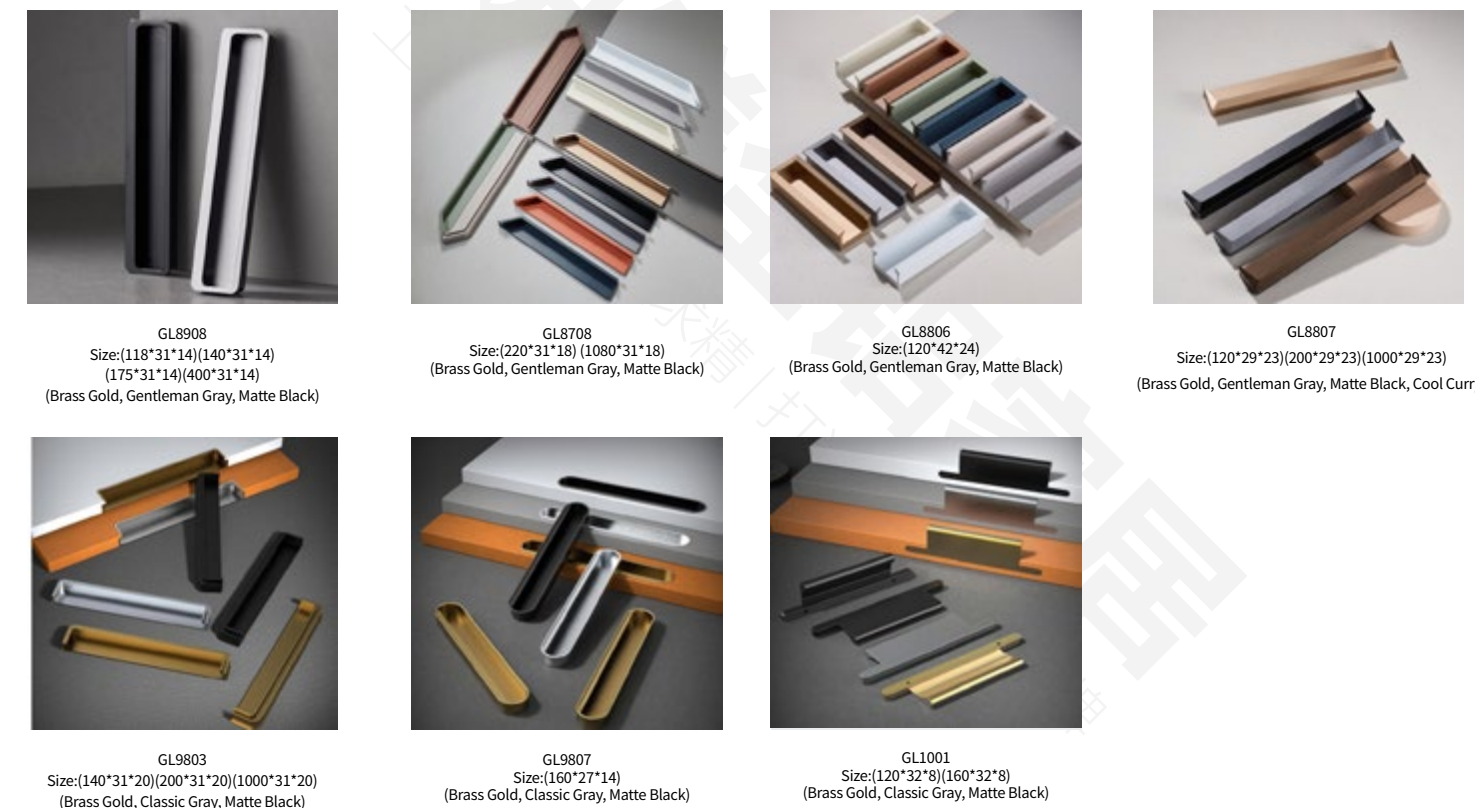

GL8908 Size:(118*31*14)(140*31*14)(175*31*14)(400*31*14) (Brass Gold, Gentleman Gray, Matte Black) GL8708 Size:(220*31*18)(1080*31*18) (Brass Gold, Gentleman Gray, Matte Black) GL8806 Size:(120*42*24) (Brass Gold, Gentleman Gray, Matte Black) GL8807 Size:(120*29*23)(200*29*23)(1000*29*23) (Brass Gold, Gentleman Gray, Matte Black, Cool Curry) GL9803 Size:(140*31*20)(200*31*20)(1000*31*20) (Brass Gold, Classic Gray, Matte Black) GL9807 Size:(160*27*14) (Brass Gold, Classic Gray, Matte Black) GL1001 Size:(120*32*8)(160*32*8) (Brass Gold, Classic Gray, Matte Black)

➤ ALL ALUMINUM ACCESSORIES SERIES



➤ WARDROBE SLIDING DOOR ACCESSORIES SERIES



➤ ALL ALUMINUM BATHROOM CABINET ACCESSORIES SERIES



➤ MECHANICAL EQUIPMENT SERIES



PUR Edge Banding Machine



CNC Cutting Machine



hinge machine



Shaped Manual Edge Banding Machine



Side punch

MECHANICAL EQUIPMENT SERIES



push-top saws



panel cutter



grommet machine



45 Degree Corner



405 Vertical double head saw 1 digital display / 3 digital display



Minimalist Specialized CNC Double Head Saw



Two-axis minimalist CNC machine tools



CNC door locking machine



Whole board sawing machine



Single head 45 degree cutting machine



Double head hinge machine



slotting machine



Disc manual cutter



Three generations of minimalist electric countersunk molds



High-efficiency CNC aluminum milling machine



air compressor



Pneumatic Concealed Latch Pressure Control Machine



18 Weld Plate Invisible (Hydraulic) Punch 2 Gun



18 Weld Plate Invisible Model A Specialized Gun



Three-in-one specialized air gun



ramrod



1806 Edgebanding Abrasives



Portable Pneumatic Latch Punching Machine

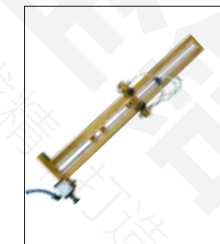

Pneumatic Whole Plate Perforation Holder



air compressor



a drier



Precision filters



gas canister



Interior Door Mould



complete set



Sliding Door Punching Machine



36/32 Frame Punching Machine



Single head latch punching machine